

# GA-N680SLI-DQ6

Intel® Core™ 2 Extreme quad-core / Core™ 2 Quad /  
Intel® Core™ 2 Extreme dual-core / Core™ 2 Duo /  
Intel® Pentium® Processor Extreme Edition /  
Intel® Pentium® D / Pentium® 4 LGA775 Processor Motherboard

## User's Manual

Rev. 2001

12ME-N680DQ6-2001R



\* The WEEE marking on the product indicates this product must not be disposed of with user's other household waste and must be handed over to a designated collection point for the recycling of waste electrical and electronic equipment!!



\* The WEEE marking applies only in European Union's member states.

## Declaration of Conformity

G.B.T. Technology Trading GmbH  
Via Manufacturer Importer  
Aussehager Weg 41, 1F 20537 Hamburg, Germany

(description of the apparatus, system, installation to which it refers)  
Motherboard  
GA-N680SLI-DQ6  
as a conformity with  
(reference to the specific standard with conformity is declared)  
in accordance with 89/338 EEC-EMC Directive

- |   |   |  |  |
|---|---|--|--|
| <input type="checkbox"/> EN 55011             | Limits and methods of measurement of radio disturbance characteristics of industrial, scientific and medical (ISM) high frequency equipment                 | <input checked="" type="checkbox"/> EN 61000-3-2 | Disturbances in supply systems caused by equipment                                   |
| <input type="checkbox"/> EN 55013             | Limits and methods of measurement of radio disturbance characteristics of broadcast receivers and associated equipment                                      | <input checked="" type="checkbox"/> EN 61000-3-3 | Disturbances in supply systems caused by electrical equipment "Voltage fluctuations" |
| <input type="checkbox"/> EN 55014-1           | Limits and methods of measurement of radio disturbance characteristics of household electrical appliances, portable tools and similar electrical appliances | <input checked="" type="checkbox"/> EN 50224     | Information Technology Equipment - Limits and methods of measurement                 |
| <input type="checkbox"/> EN 55015             | Limits and methods of measurement of radio disturbance characteristics of fluorescent lamps and luminaires  | <input type="checkbox"/> EN 50022-1              | Generic immunity standard Part 1: Residential, commercial and light industry         |
| <input type="checkbox"/> EN 55020             | Immunity from radio interference of broadcast receivers and associated equipment  | <input checked="" type="checkbox"/> EN 50022-2   | Generic immunity standard Part 2: Industrial environment                             |
| <input checked="" type="checkbox"/> EN 55022  | Limits and methods of measurement of radio disturbance characteristics of information technology equipment  | <input type="checkbox"/> EN 55014-2              | Immunity requirements for household appliances tools and similar apparatus           |
| <input type="checkbox"/> DIN VDE 0985 part 10 | Callied distribution systems. Equipment for receiving and/or distribution from sound and television signals   | <input type="checkbox"/> EN 50091-2              | EMC requirements for uninterruptible power systems (UPS)                             |
| <input type="checkbox"/> CE marking           |   |  |  |
| <input type="checkbox"/> EN 60956             | Safety requirements for mains operated electronic and related apparatus for household and similar general use   | <input checked="" type="checkbox"/> EN 60950     | Safety for information technology equipment including electrical business equipment  |
| <input type="checkbox"/> EN 60335             | Safety of household and similar electrical appliances   | <input type="checkbox"/> EN 50091-1              | General and Safety requirements for uninterruptible power systems (UPS)              |



(EC conformity marking)

The manufacturer also declares the conformity of above mentioned product with the actual required safety standards in accordance with LVD 2006/95/EEC

(Stamp)

Manufacturer/Importer  
Date: May 08, 2007

Signature: Timmy Huang  
Name: Timmy Huang

## DECLARATION OF CONFORMITY

Per FCC Part 2 Section 2.1077(a)



Responsible Party Name: **G.B.T. INC. (U.S.A.)**

Address: **17358 Railroad Street**

City of Industry, CA 91748

Phone/Fax No: **(818) 854-9338 / (818) 854-9339**

hereby declares that the product

**Product Name: Motherboard**

**Model Number: GA-N680SLI-DQ6**

Conforms to the following specifications:

FCC Part 15, Subpart B, Section 15.107(a) and Section 15.109

(a), Class B Digital Device

### Supplementary Information:

This device complies with part 15 of the FCC Rules. Operation is subject to the following two conditions: (1) This device may not cause harmful and (2) this device must accept any interference received, including that may cause undesired operation.

Representative Person's Name: ERIC LU

Signature: Eric Lu

Date: May 08, 2007

## Copyright

© 2007 GIGA-BYTE TECHNOLOGY CO., LTD. All rights reserved.

The trademarks mentioned in the manual are legally registered to their respective companies.

## Notice

The written content provided with this product is the property of Gigabyte.

No part of this manual may be reproduced, copied, translated, or transmitted in any form or by any means without Gigabyte's prior written permission. Specifications and features are subject to change without prior notice.

## Product Manual Classification

In order to assist in the use of this product, Gigabyte has categorized the user manual in the following:

- For quick installation, please refer to the "Hardware Installation Guide" included with the product.
- For detailed product information and specifications, please carefully read the "Product User Manual".
- For detailed information related to Gigabyte's unique features, please go to "Technology Guide" section on Gigabyte's website to read or download the information you need.

For more product details, please click onto Gigabyte's website at [www.gigabyte.com.tw](http://www.gigabyte.com.tw)

# Table of Contents

Item Checklist .....	6
Optional Accessories .....	6
GA-N680SLI-DQ6 Motherboard Layout .....	7
Block Diagram .....	8
Chapter 1 Hardware Installation .....	9
1-1 Considerations Prior to Installation .....	9
1-2 Feature Summary .....	10
1-3 Installation of the CPU and CPU Cooler .....	13
1-3-1 Installation of the CPU .....	13
1-3-2 Installation of the CPU Cooler .....	14
1-4 Installation of Memory .....	15
1-5 Installation of Expansion Cards .....	17
1-6 Connecting the e-SATA Cable Kit .....	18
1-7 Setup of SLI (Scalable Link Interface) Configuration .....	19
1-8 I/O Back Panel Introduction .....	22
1-9 Connectors Introduction .....	23
Chapter 2 BIOS Setup .....	35
The Main Menu (For example: BIOS Ver. : FAa) .....	37
2-1 Standard CMOS Features .....	39
2-2 Advanced BIOS Features .....	41
2-3 Integrated Peripherals .....	43
2-4 Power Management Setup .....	49
2-5 PnP/PCI Configurations .....	51
2-6 PC Health Status .....	52
2-7 MB Intelligent Tweaker(M.I.T.) .....	54
2-8 Load Fail-Safe Defaults .....	57
2-9 Load Optimized Defaults .....	57
2-10 Set Supervisor/User Password .....	58
2-11 Save & Exit Setup .....	59
2-12 Exit Without Saving .....	59

Chapter 3 Drivers Installation .....	61
3-1 Install Chipset Drivers .....	61
3-2 Software Applications .....	62
3-3 Driver CD Information .....	62
3-4 Hardware Information .....	63
3-5 Contact Us .....	63
 Chapter 4 Appendix .....	 65
4-1 Unique Software Utilities .....	65
4-1-1 EasyTune 5 Introduction .....	65
4-1-2 Xpress Recovery2 Introduction .....	66
4-1-3 Flash BIOS Method Introduction .....	68
4-1-4 Configuring SATA Hard Drive(s) .....	75
A. nVIDIA® nForce 680i SLI Southbridge .....	75
B. GIGABYTE SATA2 Controller .....	85
4-1-5 2- / 4- / 6- / 8- Channel Audio Function Introduction .....	97
4-1-6 Windows Vista ReadyBoost .....	104
4-2 Troubleshooting .....	105

## Item Checklist

- IDE Cable x 1, FDD Cable x 1
- SATA 3Gb/s Cable x 4
- I/O Shield
- e-SATA Cable x 2
- SLI Bridge (GC-SLICON6) x 1
- Retention Bracket x 1

\* The items listed above are for reference only, and are subject to change without notice.

---

## Optional Accessories

- ◆ 2 Ports USB 2.0 Cable (Part Number: 12CR1-1UB030-51/R)
- ◆ 4 Ports USB 2.0 Cable (Part Number: 12CR1-1UB030-21/R)
- ◆ 2 Ports IEEE 1394 Cable (Part Number: 12CF1-1IE008-01R)
- ◆ 2 Ports SATA Power Cable (Part Number: 12CF1-2SERPW-01R)
- ◆ S/PDIF-IN Cable (Part Number: 12CR1-1SPDIN-01R)

# GA-N680SLI-DQ6 Motherboard Layout

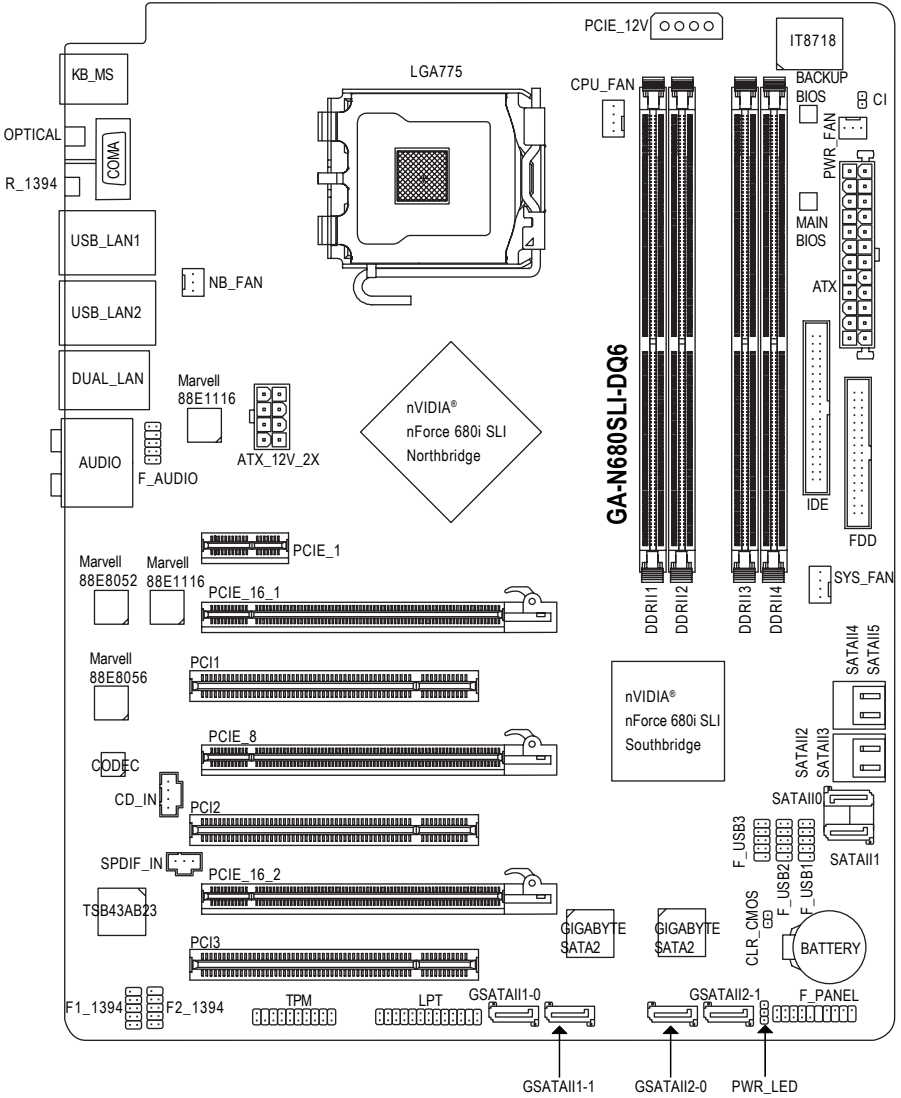

# Block Diagram

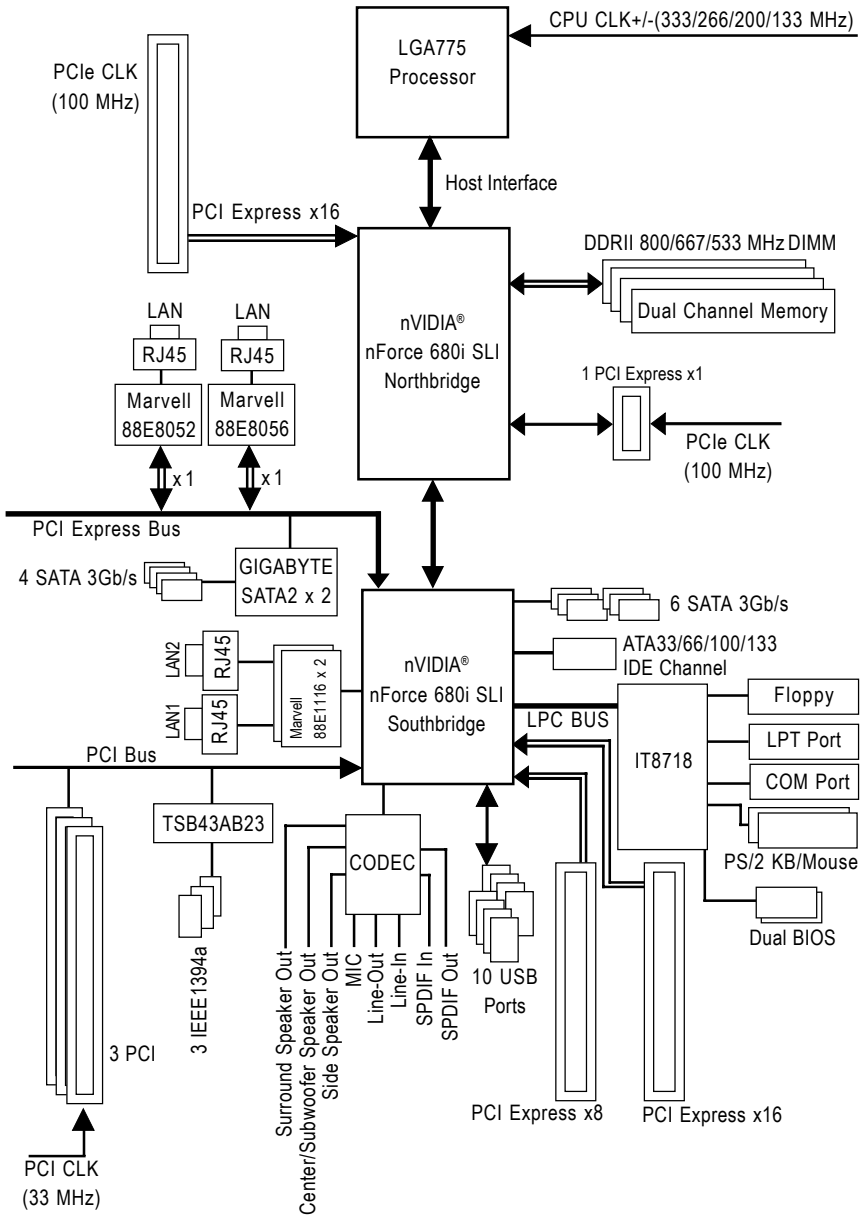



# Chapter 1 Hardware Installation

## 1-1 Considerations Prior to Installation

### Preparing Your Computer

The motherboard contains numerous delicate electronic circuits and components which can become damaged as a result of electrostatic discharge (ESD). Thus, prior to installation, please follow the instructions below:

1. Please turn off the computer and unplug its power cord.
2. When handling the motherboard, avoid touching any metal leads or connectors.
3. It is best to wear an electrostatic discharge (ESD) cuff when handling electronic components (CPU, RAM).
4. Prior to installing the electronic components, please have these items on top of an antistatic pad or within a electrostatic shielding container.
5. Please verify that the power supply is switched off before unplugging the power supply connector from the motherboard.

### Installation Notices

1. Prior to installation, please do not remove the stickers on the motherboard. These stickers are required for warranty validation.
2. Prior to the installation of the motherboard or any hardware, please first carefully read the information in the provided manual.
3. Before using the product, please verify that all cables and power connectors are connected.
4. To prevent damage to the motherboard, please do not allow screws to come in contact with the motherboard circuit or its components.
5. Please make sure there are no leftover screws or metal components placed on the motherboard or within the computer casing.
6. Please do not place the computer system on an uneven surface.
7. Turning on the computer power during the installation process can lead to damage to system components as well as physical harm to the user.
8. If you are uncertain about any installation steps or have a problem related to the use of the product, please consult a certified computer technician.

### Instances of Non-Warranty

1. Damage due to natural disaster, accident or human cause.
2. Damage as a result of violating the conditions recommended in the user manual.
3. Damage due to improper installation.
4. Damage due to use of uncertified components.
5. Damage due to use exceeding the permitted parameters.
6. Product determined to be an unofficial Gigabyte product.

## 1-2 Feature Summary

CPU	<ul style="list-style-type: none"> <li>◆ LGA775 for Intel® Core™ 2 Extreme quad-core / Core™ 2 Extreme dual-core / Core™ 2 Quad / Core™ 2 Duo / Pentium® processor Extreme Edition / Pentium® D / Pentium® 4 / Celeron® D</li> <li>◆ L2 cache varies with CPU</li> </ul>
Front Side Bus	◆ Supports 1333/1066/800/533 MHz FSB
Chipset	◆ nVIDIA® nForce 680i SLI (Northbridge: C55XE, Southbridge: MCP55P)
LAN	<ul style="list-style-type: none"> <li>◆ Onboard Marvell 88E8052/88E8056 chip (10/100/1000 Mbit)</li> <li>◆ 2 Onboard Marvell 88E1116 phy (10/100/1000 Mbit)</li> </ul>
Audio	<ul style="list-style-type: none"> <li>◆ Onboard Realtek ALC888 DD chip</li> <li>◆ Supports High Definition Audio</li> <li>◆ Supports 2 / 4 / 6 / 8 channel audio</li> <li>◆ Supports DTS (dts NEO : PC) function</li> <li>◆ Supports Dolby Digital Live</li> <li>◆ Supports S/PDIF In/Out connection</li> <li>◆ Supports CD In connection</li> </ul>
IEEE 1394	<ul style="list-style-type: none"> <li>◆ Onboard T.I. TSB43AB23 chip</li> <li>◆ 3 IEEE 1394a ports</li> </ul>
Storage	<ul style="list-style-type: none"> <li>◆ nVIDIA® nForce 680i SLI Southbridge <ul style="list-style-type: none"> <li>- 1 FDD connector supported by I/O controller, allowing connection of 1 FDD device</li> <li>- 1 IDE connector with Ultra DMA-33, ATA-66/100/133 support, allowing connection of 2 IDE devices</li> <li>- 6 SATA 3Gb/s connectors (SATAII0, SATAII1, SATAII2, SATAII3, SATAII4, SATAII5), allowing connection of 6 SATA 3Gb/s devices</li> <li>- Supports data RAID 0, RAID 1, RAID 0+1, RAID 5 and JBOD for Serial ATA</li> </ul> </li> <li>◆ GIGABYTE SATA2 x 2 Controller <ul style="list-style-type: none"> <li>- 4 SATA 3Gb/s connectors (GSATAII1-0, GSATAII1-1, GSATAII2-0, GSATAII2-1), allowing connection of 4 SATA 3Gb/s devices</li> <li>- Supports data RAID 0, RAID 1 and JBOD for Serial ATA</li> </ul> </li> </ul>
O.S Support	◆ Microsoft Windows 2000/XP
Memory	<ul style="list-style-type: none"> <li>◆ 4 DDRII DIMM memory slots (supports up to 8 GB memory)</li> <li>◆ Supports dual channel DDRII 800/667/533 unbuffered DIMMs <sup>(Note 1)</sup></li> <li>◆ Supports 1.8V DDRII DIMMs</li> <li>◆ Supports ECC type DRAM</li> </ul>
Expansion Slots	<ul style="list-style-type: none"> <li>◆ 2 PCI Express x16 slots</li> <li>◆ 1 PCI Express x8 slot</li> <li>◆ 1 PCI Express x1 slot</li> <li>◆ 3 PCI slots</li> </ul>

Internal Connectors	<ul style="list-style-type: none"> <li>◆ 1 24-pin ATX power connector</li> <li>◆ 1 8-pin ATX 12V power connector</li> <li>◆ 1 4-pin PCIe 12V power connector</li> <li>◆ 1 floppy connector</li> <li>◆ 1 IDE connector</li> <li>◆ 10 SATA 3Gb/s connectors</li> <li>◆ 1 CPU fan connector</li> <li>◆ 1 system fan connector</li> <li>◆ 1 power fan connector</li> <li>◆ 1 North Bridge fan connector</li> <li>◆ 1 front panel connector</li> <li>◆ 1 front audio connector</li> <li>◆ 1 CD In connector</li> <li>◆ 1 S/PDIF In connector</li> <li>◆ 3 USB 2.0/1.1 connectors for additional 6 ports by cables</li> <li>◆ 2 IEEE 1394a connectors for additional 2 ports by cables</li> <li>◆ 1 TPM connector</li> <li>◆ 1 LPT connector</li> <li>◆ 1 power LED connector</li> <li>◆ 1 Chassis Intrusion connector</li> </ul>
Rear Panel I/O	<ul style="list-style-type: none"> <li>◆ 1 PS/2 keyboard port</li> <li>◆ 1 PS/2 mouse port</li> <li>◆ 1 serial port</li> <li>◆ 1 IEEE 1394a port</li> <li>◆ 1 S/PDIF out port (optical)</li> <li>◆ 4 RJ-45 port</li> <li>◆ 4 USB 2.0/1.1 ports</li> <li>◆ 6 audio jacks (Line In / Line Out / MIC In / Surround Speaker Out (Rear Speaker Out) / Center/Subwoofer Speaker Out / Side Speaker Out)</li> </ul>
I/O Control	<ul style="list-style-type: none"> <li>◆ IT8718 chip</li> </ul>
Hardware Monitor	<ul style="list-style-type: none"> <li>◆ System voltage detection</li> <li>◆ CPU / System temperature detection</li> <li>◆ CPU / System / Power fan speed detection</li> <li>◆ CPU warning temperature</li> <li>◆ CPU / System / Power fan failure warning</li> <li>◆ CPU / System smart fan control</li> </ul>
BIOS	<ul style="list-style-type: none"> <li>◆ 2 4 Mbit flash ROM</li> <li>◆ Use of licensed AWARD BIOS</li> <li>◆ Supports Dual BIOS</li> <li>◆ PnP 1.0a, DMI 2.0, SM BIOS 2.3, ACPI 1.0b</li> </ul>

Additional Features	<ul style="list-style-type: none"> <li>◆ Supports @BIOS</li> <li>◆ Supports Download Center</li> <li>◆ Supports Q-Flash</li> <li>◆ Supports EasyTune<sup>(Note 2)</sup></li> <li>◆ Supports Xpress Install</li> <li>◆ Supports Xpress Recovery2</li> <li>◆ Supports Xpress BIOS Rescue</li> </ul>
Bundle Software	<ul style="list-style-type: none"> <li>◆ Norton Internet Security (OEM revision)</li> </ul>
Overclocking	<ul style="list-style-type: none"> <li>◆ Over Voltage via BIOS (CPU, DDRII, NB/PCIE, SB/PCIE, FSB, HT-Link, SB Standby) <ul style="list-style-type: none"> <li>- CPU Voltage : Adjustable CPU voltage at 0.025V <sup>(Note 3)</sup></li> <li>- DDRII Voltage : Adjustable DDRII voltage at 0.025V (Adjustable range from 0.025V to 0.775V)</li> <li>- NB/PCIE Voltage : Adjustable PCIe voltage at 0.05V (Adjustable range from 0.05V to 0.20V)</li> <li>- SB/PCIE Voltage : Adjustable PCIe voltage at 0.05V (Adjustable range from 0.05V to 0.55V)</li> <li>- FSB Voltage : Adjustable FSB voltage at 0.05V (Adjustable range from 0.05V to 0.35V)</li> <li>- HT-Link Voltage : Adjustable HT-Link voltage at 0.05V (Adjustable range from 0.05V to 0.35V)</li> <li>- SB Standby Voltage : Adjustable SB Standby voltage at 0.10V (Adjustable range from 0.10V to 0.20V)</li> </ul> </li> <li>◆ Over Clock via BIOS (CPU, DDRII, PCIE) <ul style="list-style-type: none"> <li>- PCI Express x16 Clock: Allows 1 MHz increment from 100 MHz to 150 MHz</li> <li>- PCI Express x8 Clock: Allows 1 MHz increment from 100 MHz to 150 MHz</li> <li>- Adjustable CPU, DDRII frequencies</li> </ul> </li> </ul>
Form Factor	<ul style="list-style-type: none"> <li>◆ ATX form factor; 30.5cm x 24.4cm</li> </ul>

(Note 1) To use a DDR II 800/667 memory module on the motherboard, you must install a 1333/1066/800 MHz FSB processor.

(Note 2) EasyTune functions may vary depending on different motherboards.

(Note 3) The adjustable range is dependent on CPUs.

## 1-3 Installation of the CPU and CPU Cooler



CAUTION

Before installing the CPU, please comply with the following conditions:

1. Please make sure that the motherboard supports the CPU.
2. Please take note of the one indented corner of the CPU. If you install the CPU in the wrong direction, the CPU will not insert properly. If this occurs, please change the insert direction of the CPU.
3. Please add an even layer of heat sink paste between the CPU and CPU cooler.
4. Please make sure the CPU cooler is installed on the CPU prior to system use, otherwise overheating and permanent damage of the CPU may occur.
5. Please set the CPU host frequency in accordance with the processor specifications. It is not recommended that the system bus frequency be set beyond hardware specifications since it does not meet the required standards for the peripherals. If you wish to set the frequency beyond the proper specifications, please do so according to your hardware specifications including the CPU, graphics card, memory, hard drive, etc.



NOTE

### HT functionality requirement content :

Enabling the functionality of Hyper-Threading Technology for your computer system requires all of the following platform components:

- CPU: An Intel® Pentium 4 Processor with HT Technology
- Chipset: An Intel® Chipset that supports HT Technology
- BIOS: A BIOS that supports HT Technology and has it enabled
- OS: An operation system that has optimizations for HT Technology

### 1-3-1 Installation of the CPU

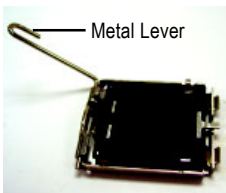

Fig. 1  
Gently lift the metal lever located on the CPU socket to the upright position.

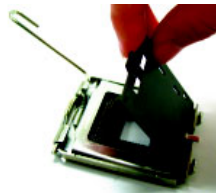

Fig. 2  
Remove the plastic covering on the CPU socket.

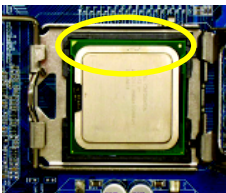

Fig. 3  
Notice the small gold colored triangle located on the edge of the CPU socket. Align the indented corner of the



Fig. 4  
Once the CPU is properly inserted, please replace the load plate and push the metal lever back into its original position.

CPU with the triangle and gently insert the CPU into position. (Grasping the CPU firmly between your thumb and forefinger, carefully place it into the socket in a straight and downwards motion. Avoid twisting or bending motions that might cause damage to the CPU during installation.)

### 1-3-2 Installation of the CPU Cooler



Fig. 1  
Please apply an even layer of CPU cooler paste on the surface of the installed CPU.

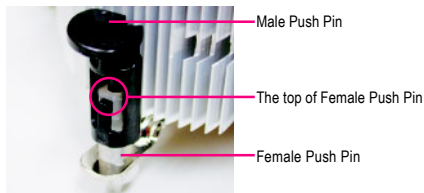

Fig. 2  
(Turning the push pin along the direction of arrow is to remove the CPU cooler, on the contrary, is to install.) Please note the direction of arrow sign on the male push pin doesn't face inwards before installation. (This instruction is only for Intel boxed fan)



Fig. 3  
Place the CPU cooler atop the CPU and make sure the push pins aim to the pin hole on the motherboard. Pressing down the push pins diagonally.

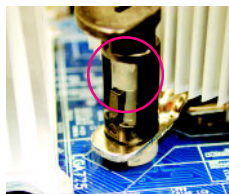

Fig. 4  
Please make sure the Male and Female push pin are joined closely. (for detailed installation instructions, please refer to the CPU cooler installation section of the user manual)

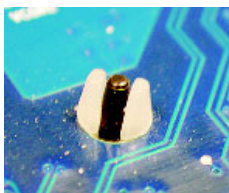

Fig. 5  
Please check the back of motherboard after installing. If the push pin is inserted as the picture, the installation is complete.

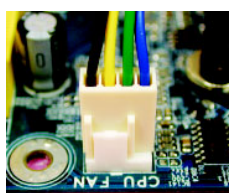

Fig. 6  
Finally, please attach the power connector of the CPU cooler to the CPU fan header located on the motherboard.



The CPU cooler may adhere to the CPU as a result of hardening of the heat paste. To prevent such an occurrence, it is suggested that either thermal tape rather than heat paste be used for heat dissipation or using extreme care when removing the CPU cooler.

## 1-4 Installation of Memory



Before installing the memory modules, please comply with the following conditions:

1. Please make sure that the memory used is supported by the motherboard. It is recommended that memory of similar capacity, specifications and brand be used.
2. Before installing or removing memory modules, please make sure that the computer power is switched off to prevent hardware damage.
3. Memory modules have a foolproof insertion design. A memory module can be installed in only one direction. If you are unable to insert the module, please switch the direction.

The motherboard supports DDRII memory modules, whereby BIOS will automatically detect memory capacity and specifications. Memory modules are designed so that they can be inserted only in one direction. The memory capacity used can differ with each slot.

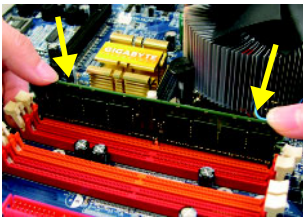
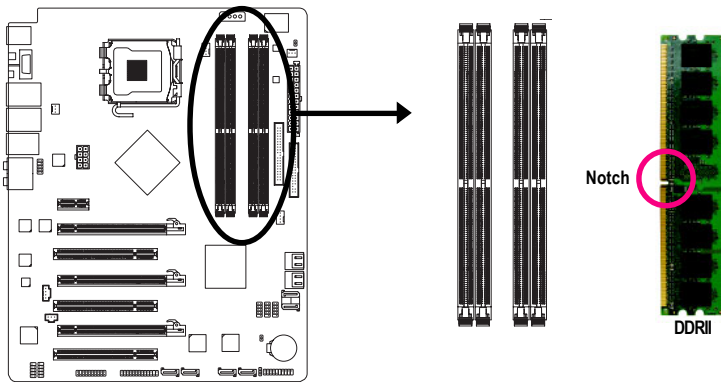

Fig.1

The DIMM socket has a notch, so the DIMM memory module can only fit in one direction. Insert the DIMM memory module vertically into the DIMM socket. Then push it down.

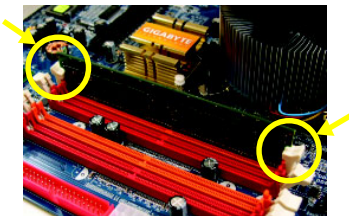

Fig.2

Close the plastic clip at both edges of the DIMM sockets to lock the DIMM module.

Reverse the installation steps when you wish to remove the DIMM module.



## Dual Channel Memory Configuration

The GA-N680SLI-DQ6 supports the Dual Channel Technology. After operating the Dual Channel Technology, the bandwidth of memory bus will double.

The GA-N680SLI-DQ6 includes 4 DIMM sockets, and each Channel has two DIMM sockets as following:

- ▶▶ Channel 0 : DDRII1, DDRII2
- ▶▶ Channel 1 : DDRII3, DDRII4

If you want to operate the Dual Channel Technology, please note the following explanations due to the limitation of chipset specifications.

1. Dual Channel mode will not be enabled if only one DDRII memory module is installed.
2. To enable Dual Channel mode with two or four memory modules (it is recommended to use memory modules of identical brand, size, chips, and speed), you must install them into DIMM sockets of the same color.

The following is a Dual Channel Memory configuration table:

(DS: Double Side, SS: Single Side, "--": Empty)

	DDRII1	DDRII2	DDRII3	DDRII4
2 memory modules	DS/SS	--	DS/SS	--
	--	DS/SS	--	DS/SS
4 memory modules	DS/SS	DS/SS	DS/SS	DS/SS



If two memory modules are to be used to achieve Dual Channel mode, we recommend installing them in DDRII1 and DDRII3 DIMM sockets.



## 1-5 Installation of Expansion Cards

To install your expansion card, follow the steps below.

1. Disconnect your system from its power source and read the expansion card's installation manual before installing the expansion card in the computer.
2. Remove your computer's chassis cover, screws and slot bracket from the computer. Ground yourself to prevent damage to your computer resulting from Electrostatic discharge (ESD).
3. Press the expansion card firmly into the expansion slot in the motherboard.
4. Make sure the metal contacts on the card are fully seated in the slot.
5. Replace the screw to secure the slot bracket of the expansion card.
6. Replace your computer's chassis cover.
7. Power on the computer, if necessary, configure required settings for the expansion card in system BIOS Setup.
8. Install related driver in the operating system.

For example: Installing a PCI Express x16 VGA card:

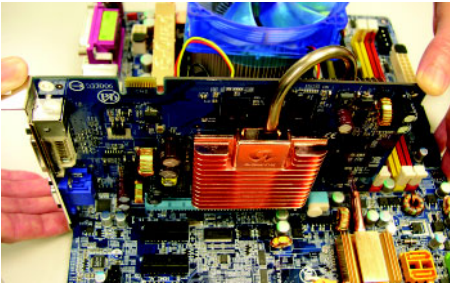

To install the VGA card:

Please align the VGA card with the PCI Express x16 slot and press down on the card. Make sure the VGA card is locked by the small white drawbar.

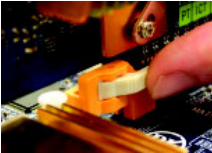

To remove the VGA card:

When you try to uninstall the VGA card on the PCI Express x16 slot, you can press the latch as the picture to the left shows to release the card.

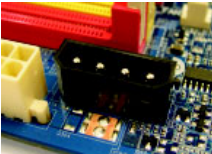

The motherboard includes a PCIe\_12V power connector, which provides extra power to the onboard PCI Express x16 slot. When installing two graphics cards, please connect the power cable from the power supply to this connector.

## 1-6 Connecting the e-SATA Cable Kit

The e-SATA cable kit allows you to connect external SATA device(s) to your system by expanding the internal SATA port(s) to the chassis back panel.



- Turn off your system and the power switch on the power supply before installing or removing the SATA bracket and SATA power cable to prevent damage to hardware.
- Insert the SATA signal cable and SATA power cable securely into the corresponding connectors when installing.

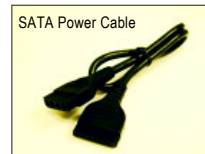
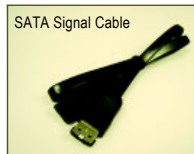
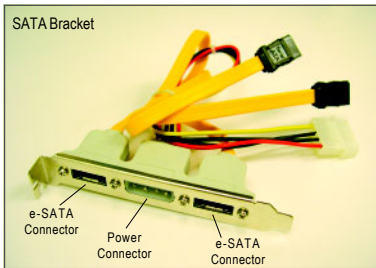

The e-SATA cable kit includes one SATA bracket, one SATA signal cable, and one SATA power cable.

Follow the steps below to install the e-SATA cable kit:

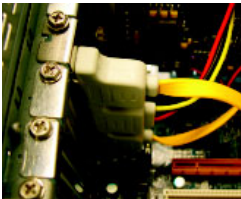

**Step 1:**  
Locate one free PCI slot and secure the SATA bracket to the chassis back panel with a screw.



**Step 2:**  
Connect the SATA cable from the bracket to the SATA port on your motherboard.

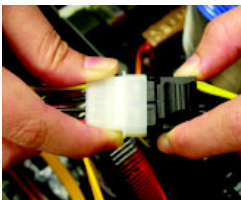

**Step 3:**  
Connect the power cable from the bracket to the power supply.



**Step 4:**  
Plug one end of the SATA signal cable into the e-SATA connector on the bracket. Then attach the SATA power cable to the power connector on the bracket.



**Step 5:**  
Connect the other ends of the SATA signal cable and SATA power cable to your SATA devices. For SATA device in external enclosure, you only need to connect the SATA signal cable. Before connecting the SATA signal cable, make sure to turn off the power of the external enclosure.

## 1-7 Setup of SLI (Scalable Link Interface) Configuration

nVIDIA® nForce 680i SLI offers blistering graphics performance with the ability to bridge two NVIDIA SLI-ready PCI Express™ graphics cards! The SLI design takes advantage of the increased bandwidth of the PCI Express™ bus architecture, features hardware and software innovations within NVIDIA GPU (graphics processing unit) and the nVIDIA® nForce 680i SLI chipset. Together, the NVIDIA SLI technologies work seamlessly to allow two graphics cards to operate in parallel and share the work and deliver heart-pounding PC performance. This section introduces steps to configure an SLI system on the GA-N680SLI-DQ6 motherboard.

### Before you begin--



The exact power requirements will depend on your overall system configurations. You need a power supply that can provide sufficient and stable power to your system and the two SLI graphics cards. Please refer to the table below to check recommended power for different systems.

System configuration	System A	System B
Processors	Intel QX6700	Intel X6800
PCIe x16 video cards	2±iNVIDIA 6800 Ultra cards	2±iNVIDIA 6600 GT cards
DDR memory modules	4 DIMMs	2 DIMMs
Hard drives/Optical drives	4 hard drives + 2 optical drives	1 hard drives + 1 optical drives
Expansion cards	1 PCIe x1 card + 2 PCI cards	0
USB devices	10	4
IEEE 1394 devices	1	0
Required +12V current	25A or above	20A or above
Power supply requirement	500W or above	350W or above

If you wish to enable the SLI function, install two SLI-ready graphics cards into the PCIe\_16\_1 and PCIe\_16\_2 slots. (It is recommended to use graphics cards of identical brand and chips. For example: GIGABYTE GV-NX76T256D-RH).

If you want to set up a single graphics card system, we recommend installing the graphics card on the PCIe\_16\_1 slot to ensure better display performance.

## Connecting Two Graphics Cards:

Step 1: Observe the steps in "1-5 Installation of Expansion Cards" and install two SLI-ready graphics cards of the same model to the PCIE\_16\_1 and PCIE\_16\_2 slots.

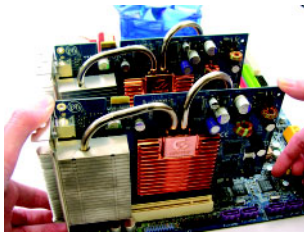

Step 2: Insert the SLI bridge (the GC-SLICON6) to the SLI gold edge connector on top of both cards. Make sure the two mini female slots on the bridge connector securely fit onto the SLI gold edge connectors of both cards.

Female slots on the bridge connector



Gold edge connector on the top of graphics card

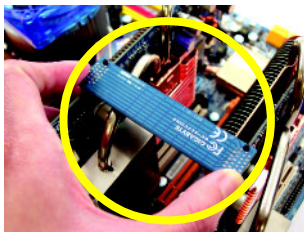
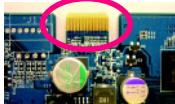

Step 3: In order to securely fix the bridge connector between the two cards, you must install the retention bracket included with the motherboard and secure the retention bracket to the chassis back panel with a screw.



retention bracket

place this part on the top of the bridge connector.

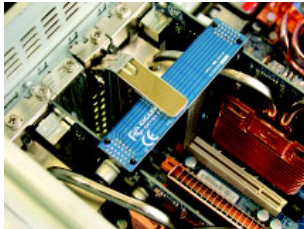

Step 4: Plug the display cable into the graphics card which on the PCIE\_16\_1 slot<sup>(Note)</sup>.

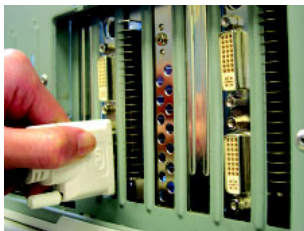

(Note) If you want to enable the SLI function, you must plug the display cable into the graphics card which on the PCIE\_16\_1 slot.

## Graphics Card Driver Setting:

Step 1: After installing graphics card driver in operating system, right-click the NVIDIA icon in your system tray and then select **NVIDIA Display**. The NVIDIA control panel will appear.

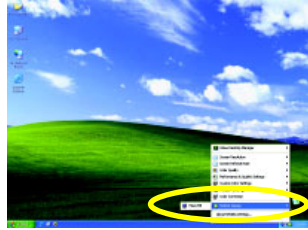

Step 2: Select **SLI multi-GPU** from the side menu and then select the **Enable SLI multi-GPU** checkbox in the SLI multi-GPU dialog box. System will restart after you click **Apply**. Then the SLI configuration is completed.

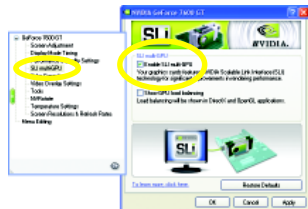

## 1-8 I/O Back Panel Introduction

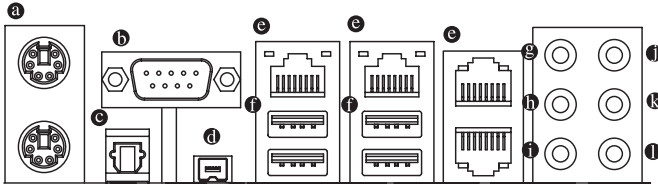

### ❶ PS/2 Keyboard and PS/2 Mouse Connector

To install a PS/2 port keyboard and mouse, plug the mouse to the upper port (green) and the keyboard to the lower port (purple).

### ❷ COMA

Connects to serial-based mouse or data processing devices.

### ❸ OPTICAL

The S/PDIF optical output port is capable of providing digital audio to external speakers or compressed AC3 data to an external Dolby Digital Decoder via an optical cable.

### ❹ IEEE 1394 Port (4 Pins Connector)

Serial interface standard set by Institute of Electrical and Electronics Engineers, which has features like high speed, high bandwidth and hot plug.

### ❺ LAN Port

The provided Internet connection is Gigabit Ethernet , providing data transfer speeds of 10/100/1000 Mbps.

### ❻ USB Port

Before you connect your device(s) into USB connector(s), please make sure your device(s) such as USB keyboard, mouse, scanner, zip, speaker...etc. have a standard USB interface. Also make sure your OS supports USB controller. If your OS does not support USB controller, please contact OS vendor for possible patch or driver upgrade. For more information please contact your OS or device(s) vendors.

### ❼ Center/Subwoofer Speaker Out

The default Center/Subwoofer Speaker Out jack. Center/Subwoofer speakers can be connected to Center/Subwoofer Speaker Out jack.

### ❽ Surround Speaker Out (Rear Speaker Out)

The default Surround Speaker Out (Rear Speaker Out) jack. Rear surround speakers can be connected to Surround Speaker Out (Rear Speaker Out) jack.

### ❾ Side Speaker Out

The default Side Speaker Out jack. Surround side speakers can be connected to Side Speaker Out jack.

### ❿ Line In

The default Line In jack. Devices like CD-ROM, walkman etc. can be connected to Line In jack.

### ⓫ Line Out (Front Speaker Out)

The default Line Out (Front Speaker Out) jack. Stereo speakers, earphone or front surround speakers can be connected to Line Out (Front Speaker Out) jack.

## ● MIC In

The default MIC In jack. Microphone must be connected to MIC In jack.



NOTE

In addition to the default speakers settings, the ②~④ audio jacks can be reconfigured to perform different functions via the audio software. Only microphones still MUST be connected to the default Mic In jack (●). Please refer to the 2-/4-/6-/8- channel audio setup steps for detailed software configuration information.

## 1-9 Connectors Introduction

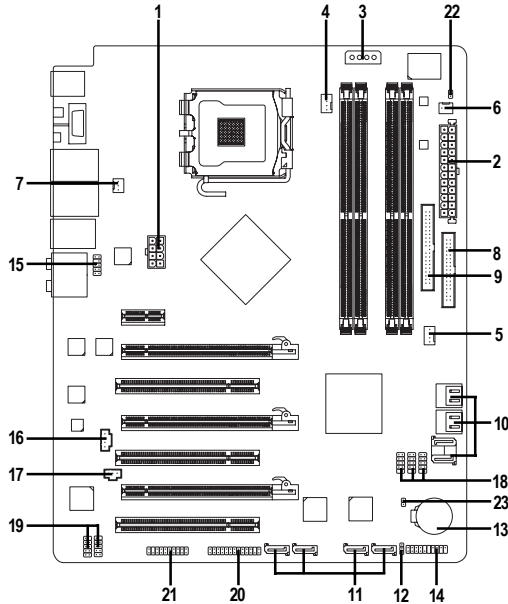

1) ATX_12V_2X	12) PWR_LED
2) ATX (Power Connector)	13) BATTERY
3) PCIE_12V	14) F_PANEL
4) CPU_FAN	15) F_AUDIO
5) SYS_FAN	16) CD_IN
6) PWR_FAN	17) SPDIF_IN
7) NB_FAN	18) F_USB1 / F_USB2 / F_USB3
8) FDD	19) F1_1394 / F2_1394
9) IDE	20) LPT
10) SATAII0 / 1 / 2 / 3 / 4 / 5	21) TPM
11) GSATAII0-0 / GSATAII1-1 / GSATAII2-0 / GSATAII2-1	22) CI
	23) CLR_CMOS

## 1/2) ATX\_12V\_2X / ATX (Power Connector)

With the use of the power connector, the power supply can supply enough stable power to all the components on the motherboard. Before connecting the power connector, please make sure that all components and devices are properly installed. Align the power connector with its proper location on the motherboard and connect tightly.

The ATX 12V (2x4-pin) power connector mainly supplies power to the CPU. If the ATX 12V (2x4) power connector is not connected, the system will not start. If you wish to install a power supply that provides ATX 12V (2x2-pin) power connector, please connect the ATX 12V power connector to the Pin 3, 4, 7, 8 of the onboard ATX\_12V\_2X power connector according to the pin definitions.

**Important** Use of a power supply providing an ATX 12V (2x4-pin) power connector is recommended by processor manufacturer when using Intel® Pentium® Extreme Edition series processors (130W or greater).

**Caution!** Please use a power supply that is able to handle the system voltage requirements. It is recommended that a power supply that can withstand high power consumption be used (400W or greater). If a power supply is used that does not provide the required power, the result can lead to an unstable system or a system that is unable to start. If you use a power supply that provides a 24-pin ATX or 2x4 pin ATX 12V power connector, please remove the small cover on the power connector on the motherboard before plugging in the power cord; otherwise, please do not remove it.

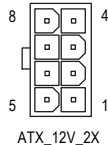
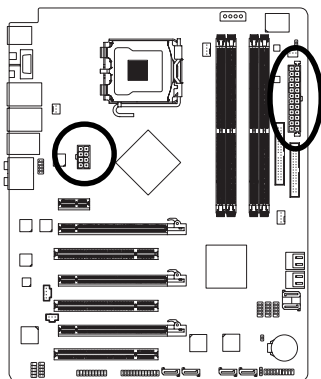

Pin No.	Definition
1	GND
2	GND
3	GND
4	GND
5	+12V
6	+12V
7	+12V
8	+12V

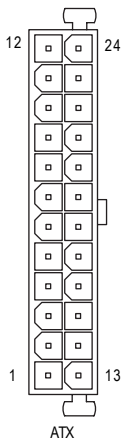

Pin No.	Definition	Pin No.	Definition
1	3.3V	13	3.3V
2	3.3V	14	-12V
3	GND	15	GND
4	+5V	16	PS_ON(soft On/Off)
5	GND	17	GND
6	+5V	18	GND
7	GND	19	GND
8	Power Good	20	-5V
9	5V SB(stand by +5V)	21	+5V
10	+12V	22	+5V
11	+12V(Only for 24-pin ATX)	23	+5V (Only for 24-pin ATX)
12	3.3V(Only for 24-pin ATX)	24	GND(Only for 24-pin ATX)



### 3) PCIE\_12V (Power Connector)

This power connector provides extra power to the onboard PCI Express x16 slot. When installing two graphics cards, please connect the power cable from the power supply to this connector, or system instability may occur.

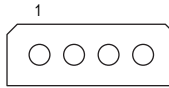
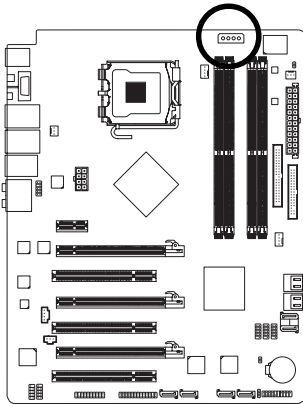

Pin No.	Definition
1	NC
2	GND
3	GND
4	+12V

### 4/5/6) CPU\_FAN / SYS\_FAN / PWR\_FAN (Cooler Fan Power Connector)

The cooler fan power connector supplies a +12V power voltage via a 3-pin/4-pin(CPU\_FAN/ SYS\_FAN) power connector and possesses a foolproof connection design.

Most coolers are designed with color-coded power connector wires. A red power connector wire indicates a positive connection and requires a +12V power voltage. The black connector wire is the ground wire (GND).

Remember to connect the CPU/system/power fan cable to the CPU\_FAN/SYS\_FAN/PWR\_FAN connector to prevent CPU damage or system hanging caused by overheating.

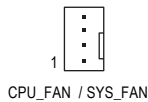
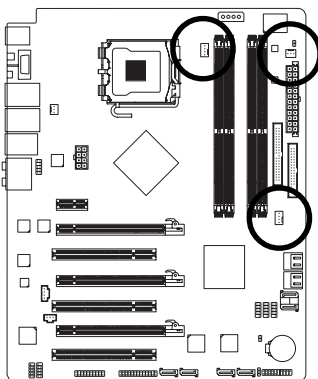

CPU\_FAN / SYS\_FAN :

Pin No.	Definition
1	GND
2	+12V / Speed Control
3	Sense
4	Speed Control



PWR\_FAN :

Pin No.	Definition
1	GND
2	+12V
3	Sense

## 7) NB\_FAN (North Bridge Fan Header)

Connect the North Bridge fan cable to this header. The fan header has a foolproof insertion design. When connecting a fan cable, be sure to connect it in the correct orientation. Most fans are designed with color-coded power connector wires. A red power connector wire indicates a positive connection and requires a +12V voltage. The black connector wire is the ground wire.

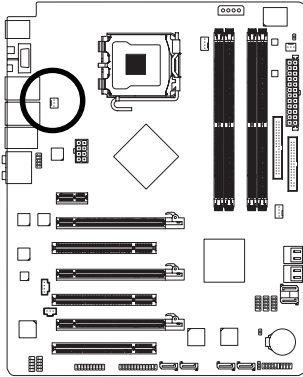

Pin No.	Definition
1	GND
2	+12V
3	NC

## 8) FDD (Floppy Connector)

The FDD connector is used to connect the FDD cable while the other end of the cable connects to the FDD drive. The types of FDD drives supported are: 360 KB, 720 KB, 1.2 MB, 1.44 MB and 2.88 MB. Before attaching the FDD cable, please take note of the foolproof groove in the FDD connector.

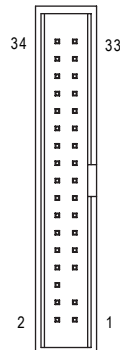
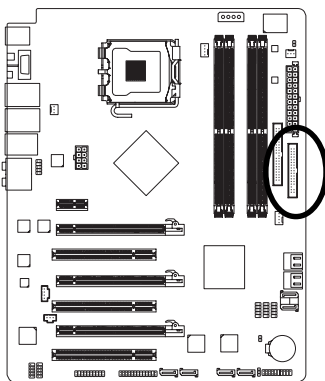

### 9) IDE (IDE Connector)

An IDE device connects to the computer via an IDE connector. One IDE connector can connect to one IDE cable, and the single IDE cable can then connect to two IDE devices (hard drive or optical drive). If you wish to connect two IDE devices, please set the jumper on one IDE device as Master and the other as Slave (for information on settings, please refer to the instructions located on the IDE device). Before attaching the IDE cable, please take note of the foolproof groove in the IDE connector.

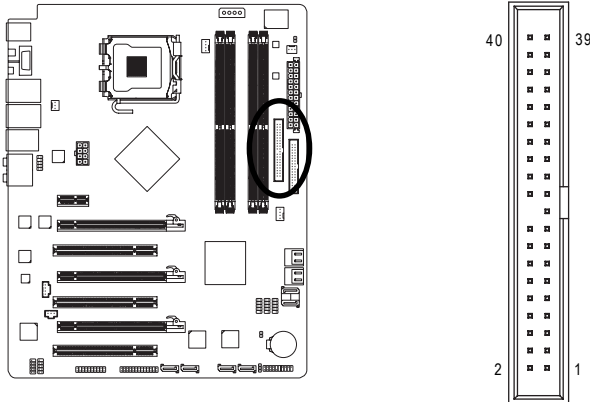

### 10) SATAII0 / 1 / 2 / 3 / 4 / 5 (SATA 3Gb/s Connector, Controlled by nVIDIA® nForce 680i SLI Southbridge)

SATA 3Gb/s can provide up to 300 MB/s transfer rate. Please refer to the BIOS setting for the SATA 3Gb/s and install the proper driver in order to work properly.

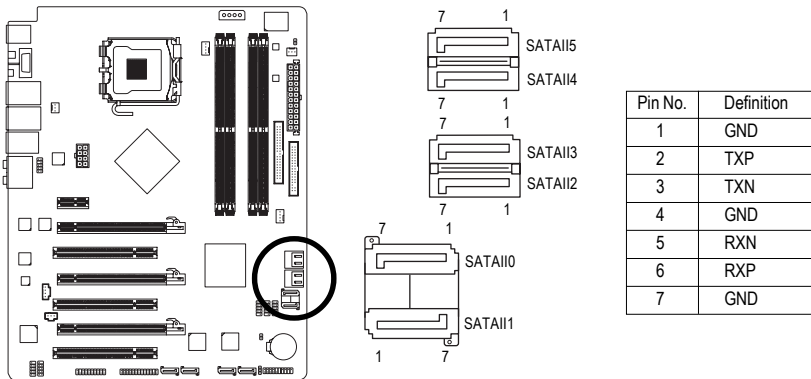

## 11) GSATAII1-0 / GSATAII1-1 / GSATAII2-0 / GSATAII2-1 (SATA 3Gb/s Connector, Controlled by GIGABYTE SATA2)

SATA 3Gb/s can provide up to 300 MB/s transfer rate. Please refer to the BIOS setting for the SATA 3Gb/s and install the proper driver in order to work properly.

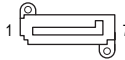
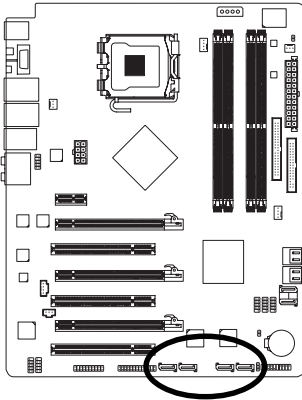

Pin No.	Definition
1	GND
2	TXP
3	TXN
4	GND
5	RXN
6	RXP
7	GND

## 12) PWR\_LED

The PWR\_LED connector is connected with the system power indicator to indicate whether the system is on/off. It will blink when the system enters suspend mode(S1).

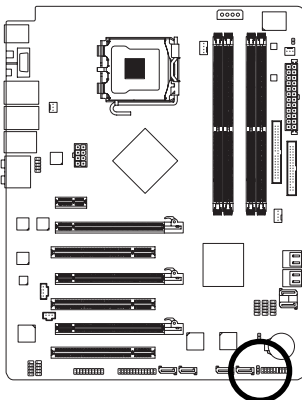

Pin No.	Definition
1	MPD+
2	MPD-
3	MPD-

### 13) BATTERY

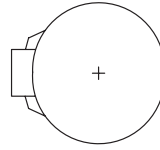
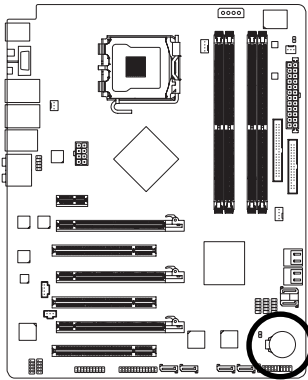

- ❖ Danger of explosion if battery is incorrectly replaced.
- ❖ Replace only with the same or equivalent type recommended by the manufacturer.
- ❖ Dispose of used batteries according to the manufacturer's instructions.

If you want to erase CMOS...

1. Turn off the computer and unplug the power cord.
2. Gently take out the battery and put it aside for about one minute.  
(Or you can use a metal object to connect the positive and negative pins in the battery holder to make them short for five seconds.)
3. Re-install the battery.
4. Plug the power cord in and turn on the computer.

### 14) F\_PANEL (Front Panel Jumper)

Please connect the power LED, PC speaker, reset switch and power switch etc. of your chassis front panel to the F\_PANEL connector according to the pin assignment below.

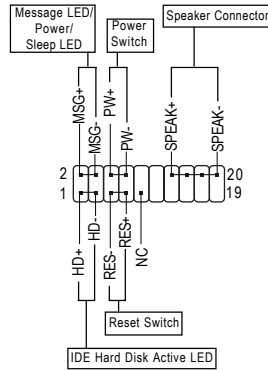
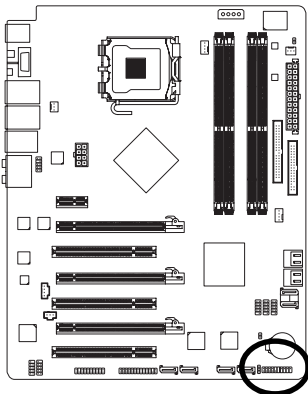

MSG (Message LED/Power/Sleep LED) (Yellow)	Pin 1: LED anode(+) Pin 2: LED cathode(-)
PW (Power Switch) (Red)	Open: Normal Close: Power On/Off
SPEAK (Speaker Connector) (Amber)	Pin 1: Power Pin 2- Pin 3: NC Pin 4: Data(-)
HD (IDE Hard Disk Active LED) (Blue)	Pin 1: LED anode(+) Pin 2: LED cathode(-)
RES (Reset Switch) (Green)	Open: Normal Close: Reset Hardware System
NC (Purple)	NC

## 15) F\_AUDIO (Front Audio Connector)

This connector supports either HD (High Definition) or AC97 front panel audio module. If you wish to use the front audio function, connect the front panel audio module to this connector. Check the pin assignments carefully while you connect the front panel audio module. Incorrect connection between the module and connector will make the audio device unable to work or even damage it. For optional front panel audio module, please contact your chassis manufacturer.

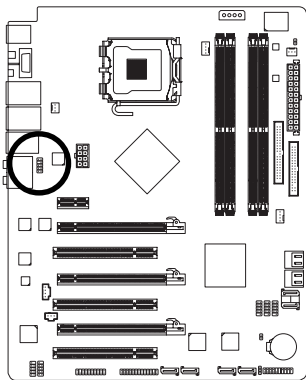

HD Audio:

Pin No.	Definition
1	MIC2_L
2	GND
3	MIC2_R
4	-ACZ_DET
5	LINE2_R
6	FSENSE1
7	FAUDIO_JD
8	No Pin
9	LINE2_L
10	FSENSE2

AC'97 Audio:

Pin No.	Definition
1	MIC
2	GND
3	MIC Power
4	NC
5	Line Out (R)
6	NC
7	NC
8	No Pin
9	Line Out (L)
10	NC



NOTE

By default, the audio driver is configured to support HD Audio. To connect an AC97 front panel audio module to this connector, please refer to the instructions on page 101 about the software settings.

## 16) CD\_IN (CD IN Connector)

Connect CD-ROM or DVD-ROM audio out to the connector.

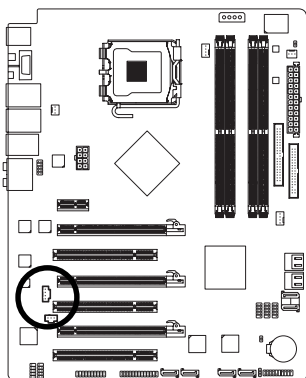

Pin No.	Definition
1	CD-L
2	GND
3	GND
4	CD-R

### 17) SPDIF\_IN (S/PDIF In Connector)

Use S/PDIF IN feature only when your device has digital output function. Be careful with the polarity of the SPDIF\_IN connector. Check the pin assignment carefully while you connect the S/PDIF cable, incorrect connection between the cable and connector will make the device unable to work or even damage it. For optional S/PDIF cable, please contact your local dealer.

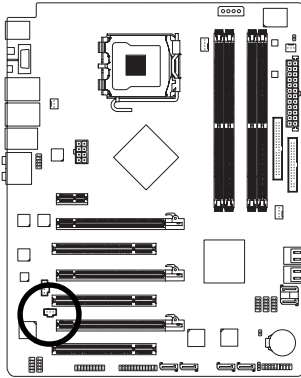

Pin No.	Definition
1	Power
2	SPDIFI
3	GND

### 18) F\_USB1 / F\_USB2 / F\_USB3 (Front USB Connector)

Be careful with the polarity of the front USB connector. Check the pin assignment carefully while you connect the front USB cable, incorrect connection between the cable and connector will make the device unable to work or even damage it. For optional front USB cable, please contact your local dealer.

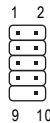
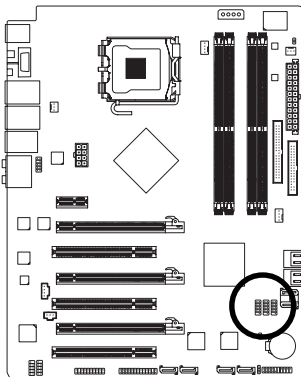

Pin No.	Definition
1	Power (5V)
2	Power (5V)
3	USB DX-
4	USB DY-
5	USB DX+
6	USB DY+
7	GND
8	GND
9	No Pin
10	NC

## 19) F1\_1394 / F2\_1394 (Front IEEE 1394 Connector)

Serial interface standard set by Institute of Electrical and Electronics Engineers, which has features like high speed, high bandwidth and hot plug. Be careful with the polarity of the IEEE 1394 connector. Check the pin assignment carefully while you connect the IEEE 1394 cable, incorrect connection between the cable and connector will make the device unable to work or even damage it. For optional IEEE 1394 cable, please contact your local dealer.

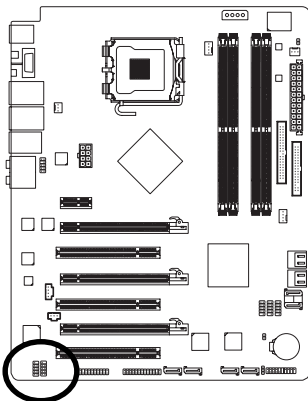

Pin No.	Definition
1	TPA+
2	TPA-
3	GND
4	GND
5	TPB+
6	TPB-
7	Power (12V)
8	Power (12V)
9	No Pin
10	GND

## 20) LPT Connector

The LPT connector allows connection of a printer, scanner and other peripheral devices.

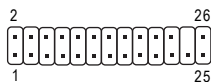
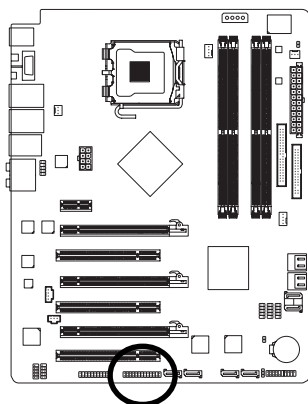

Pin No.	Definition	Pin No.	Definition
1	STB-	14	GND
2	AFD-	15	PD6
3	PD0	16	GND
4	ERR-	17	PD7
5	PD1	18	GND
6	INIT-	19	ACK-
7	PD2	20	GND
8	SLIN-	21	BUSY
9	PD3	22	GND
10	GND	23	PE
11	PD4	24	No Pin
12	GND	25	SLCT
13	PD5	26	GND



## 21) TPM Connector (Trusted Platform Module)

Please contact your nearest dealer for optional TPM cable.

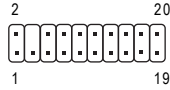
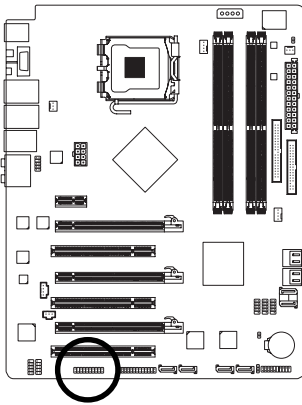

Pin No.	Definition	Pin No.	Definition
1	LCLK	11	LAD0
2	GND	12	GND
3	LFRAME	13	RSVO
4	No Pin	14	RSV1
5	LRESET	15	SB3V
6	VCC5	16	SERIRQ
7	LAD3	17	GND
8	LAD2	18	CLKRUN
9	VCC3	19	LPCPD
10	LAD1	20	RSV2

## 22) CI (Chassis Intrusion, Case Open)

This 2-pin connector allows your system to detect if the chassis cover is removed. You can check the "Case Opened" status in BIOS Setup.

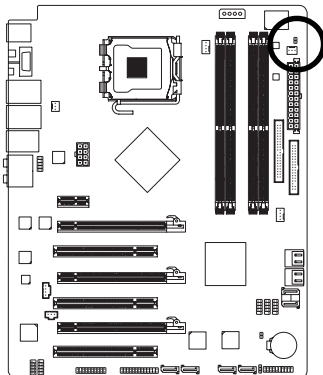



Pin No.	Definition
1	Signal
2	GND

### 23) CLR\_CMOS (Clear CMOS)

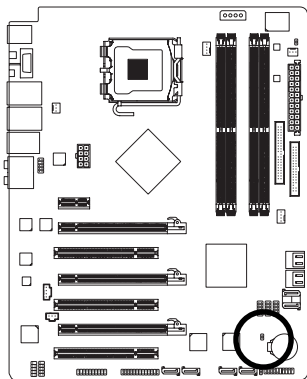
You may clear the CMOS data to its default values by this header. To clear CMOS, temporarily short the two pins. Default doesn't include the jumper to avoid improper use of this header.



 Open: Normal

 Short: Clear CMOS

## Chapter 2 BIOS Setup

BIOS (Basic Input and Output System) includes a CMOS SETUP utility which allows user to configure required settings or to activate certain system features.

The CMOS SETUP saves the configuration in the CMOS SRAM of the motherboard.

When the power is turned off, the battery on the motherboard supplies the necessary power to the CMOS SRAM.

When the power is turned on, pressing the <Del> button during the BIOS POST (Power-On Self Test) will take you to the CMOS SETUP screen. You can enter the BIOS setup screen by pressing "Ctrl + F1".

If you wish to upgrade to a new BIOS, either Gigabyte's Q-Flash or @BIOS utility can be used.

Q-Flash allows the user to quickly and easily update or backup BIOS without entering the operating system.

@BIOS is a Windows-based utility that does not require users to boot to DOS before upgrading BIOS but directly download and update BIOS from the Internet.

### CONTROL KEYS

<↑> <↓> <←> <→>	Move to select item
<Enter>	Select Item
<Esc>	Main Menu - Quit and not save changes into CMOS Status Page Setup Menu and Option Page Setup Menu - Exit current page and return to Main Menu
<Page Up>	Increase the numeric value or make changes
<Page Down>	Decrease the numeric value or make changes
<F1>	General help, only for Status Page Setup Menu and Option Page Setup Menu
<F2>	Item Help
<F5>	Restore the previous CMOS value from CMOS, only for Option Page Setup Menu
<F6>	Load the fail-safe default CMOS value from BIOS default table
<F7>	Load the Optimized Defaults
<F8>	Dual BIOS/Q-Flash utility
<F9>	System Information
<F10>	Save all the CMOS changes, only for Main Menu
<F11>	Save CMOS to BIOS - CMOS Profiles
<F12>	Load CMOS from BIOS - CMOS Profiles

### Main Menu

The on-line description of the highlighted setup function is displayed at the bottom of the screen.

### Status Page Setup Menu / Option Page Setup Menu

Press F1 to pop up a small help window that describes the appropriate keys to use and the possible selections for the highlighted item. To exit the Help Window press <Esc>.



Because BIOS flashing is potentially risky, please do it with caution and avoid inadequate operation that may result in system malfunction.

**Startup Screen:****<TAB> : POST Screen**

Press the **TAB** key to see BIOS POST screen.

(To show the BIOS POST screen at system startup, refer to the instructions on the Full Screen LOGO Show item on page 42.)

**<DEL> : BIOS Setup/Dual BIOS**

Press the **DELETE** key to enter BIOS Setup program.

**<F9> : Xpress Recovery2**

Press the **F9** key to enter the Xpress Recovery2 screen.

**<F12> : Boot Menu**

Press the **F12** key to enter Boot Menu to select the first boot device.

**<End> : Qflash**

Press the **End** key to enter Q-Flash utility.

## The Main Menu (For example: BIOS Ver. : FAa)

Once you enter Award BIOS CMOS Setup Utility, the Main Menu (as figure below) will appear on the screen. Use arrow keys to select among the items and press <Enter> to accept or enter the sub-menu.

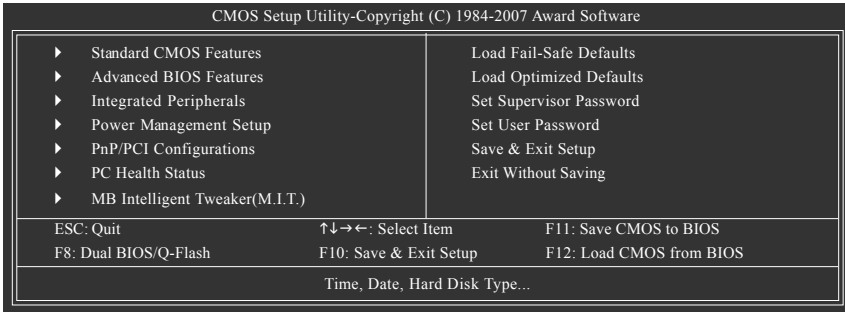

-  **NOTE**
1. If you don't find the settings you want, press "Ctrl+F1" to access advanced options.
  2. Select the **Load Optimized Defaults** item in the BIOS Setup when somehow the system is not stable as usual. This action makes the system reset to the default settings for stability.
  3. The BIOS Setup menus described in this chapter are for reference only and may differ from the exact settings for your motherboard.

### BIOS Setting Recovery

#### ▶ F11 : Save CMOS to BIOS

This function allows you to make a record of the current CMOS settings as a profile. You can create up to 8 profiles (Profile 1-8) and give each of them a name.

#### ▶ F12 : Load CMOS from BIOS

If your system becomes unstable and you load the default BIOS settings, you can use this function to reload the CMOS settings with a CMOS settings profile created before, without the hassles of resetting the CMOS configurations.

#### ■ **Standard CMOS Features**

This setup page includes all the items in standard compatible BIOS.

#### ■ **Advanced BIOS Features**

This setup page includes all the items of Award special enhanced features.

#### ■ **Integrated Peripherals**

This setup page includes all onboard peripherals.

#### ■ **Power Management Setup**

This setup page includes all the items of Green function features.

#### ■ **PnP/PCI Configuration**

This setup page includes all the configurations of PCI & PnP ISA resources.

#### ■ **PC Health Status**

This setup page is the System auto detect Temperature, voltage, fan, speed.

- **MB Intelligent Tweaker(M.I.T.)**

This setup page is control CPU clock and frequency ratio.

- **Load Fail-Safe Defaults**

Fail-Safe Defaults indicates the value of the system parameters which the system would be in safe configuration.

- **Load Optimized Defaults**

Optimized Defaults indicates the value of the system parameters which the system would be in best performance configuration.

- **Set Supervisor Password**

Change, set, or disable password. It allows you to limit access to the system and Setup, or just to Setup.

- **Set User Password**

Change, set, or disable password. It allows you to limit access to the system.

- **Save & Exit Setup**

Save CMOS value settings to CMOS and exit setup.

- **Exit Without Saving**

Abandon all CMOS value changes and exit setup.

## 2-1 Standard CMOS Features

CMOS Setup Utility-Copyright (C) 1984-2007 Award Software Standard CMOS Features		
Date (mm:dd:yy)	Fri, Apr 20 2007	Item Help
Time (hh:mm:ss)	22:31:24	Menu Level▶
▶ IDE Channel 0 Master	[None]	
▶ IDE Channel 0 Slave	[None]	
▶ IDE Channel 2 Master	[None]	
▶ IDE Channel 3 Master	[None]	
▶ IDE Channel 4 Master	[None]	
▶ IDE Channel 5 Master	[None]	
▶ IDE Channel 6 Master	[None]	
▶ IDE Channel 7 Master	[None]	
Drive A	[1.44M, 3.5"]	
Floppy 3 Mode Support	[Disabled]	
Halt On	[All, But Keyboard]	
Base Memory	1664K	
Extended Memory	511M	
↑↓→←: Move    Enter: Select    +/-/PU/PD: Value    F10: Save    ESC: Exit    F1: General Help F5: Previous Values    F6: Fail-Safe Defaults    F7: Optimized Defaults		

### ☞ Date

The date format is <week>, <month>, <day>, <year>.

- ▶▶ Week      The week, from Sun to Sat, determined by the BIOS and is display-only
- ▶▶ Month     The month, Jan. Through Dec.
- ▶▶ Day        The day, from 1 to 31 (or the maximum allowed in the month)
- ▶▶ Year        The year, from 2000 through 2099

### ☞ Time

The times format in <hour> <minute> <second>. The time is calculated base on the 24-hour military-time clock. For example, 1 p.m. is 13:0:0.

### ☞ IDE Channel 0 Master, Slave

#### ▶▶ IDE HDD Auto-Detection

Press "Enter" to select this option for automatic device detection.

#### ▶▶ IDE Device Setup. You can use one of three methods:

- Auto      Allows BIOS to automatically detect IDE/SATA devices during POST(default)
- None     Select this if no IDE/SATA devices are used and the system will skip the automatic detection step and allow for faster system start up.
- Manual    User can manually input the correct settings.

#### ▶▶ Access Mode Use this to set the access mode for the hard drive. The four options are: CHS/LBA/Large/Auto(default:Auto)

### ☞ IDE Channel 2/3/4/5/6/7 Master

#### ▶▶ IDE HDD Auto-Detection

Press "Enter" to select this option for automatic device detection.

#### ▶▶ Extended IDE Drive. You can use one of two methods:

- Auto      Allows BIOS to automatically detect IDE/SATA devices during POST(default)
- None     Select this if no IDE/SATA devices are used and the system will skip the automatic detection step and allow for faster system start up.

- ▶▶ Access Mode Use this to set the access mode for the hard drive. The two options are: Large/Auto(default:Auto)
- ▶▶ Capacity Capacity of correctly installed hard drive.
- ▶▶ Cylinder Number of cylinders
- ▶▶ Head Number of heads
- ▶▶ Precomp Write precomp
- ▶▶ Landing Zone Landing zone
- ▶▶ Sector Number of sectors

### ☞ Drive A

The category identifies the types of floppy disk drive A that has been installed in the computer.

- ▶▶ None No floppy drive installed.
- ▶▶ 360K, 5.25" 5.25 inch PC-type standard drive; 360 K byte capacity.
- ▶▶ 1.2M, 5.25" 5.25 inch AT-type high-density drive; 1.2 M byte capacity.  
(3.5 inch when 3 Mode is Enabled).
- ▶▶ 720K, 3.5" 3.5 inch double-sided drive; 720 K byte capacity.
- ▶▶ 1.44M, 3.5" 3.5 inch double-sided drive; 1.44 M byte capacity.
- ▶▶ 2.88M, 3.5" 3.5 inch double-sided drive; 2.88 M byte capacity.

### ☞ Floppy 3 Mode Support (for Japan Area)

- ▶▶ Disabled Normal Floppy Drive. (Default value)
- ▶▶ Drive A Drive A is 3 mode Floppy Drive.

### ☞ Halt on

The category determines whether the computer will stop if an error is detected during power up.

- ▶▶ No Errors The system boot will not stop for any error that may be detected and you will be prompted.
- ▶▶ All Errors Whenever the BIOS detects a non-fatal error the system will be stopped.
- ▶▶ All, But Keyboard The system boot will not stop for a keyboard error; it will stop for all other errors. (Default value)
- ▶▶ All, But Diskette The system boot will not stop for a disk error; it will stop for all other errors.
- ▶▶ All, But Disk/Key The system boot will not stop for a keyboard or disk error; it will stop for all other errors.

### ☞ Memory

The category is display-only which is determined by POST (Power On Self Test) of the BIOS.

#### ▶▶ Base Memory

The POST of the BIOS will determine the amount of base (or conventional) memory installed in the system.

The value of the base memory is typically 512 K for systems with 512 K memory installed on the motherboard, or 640 K for systems with 640 K or more memory installed on the motherboard.

#### ▶▶ Extended Memory

The BIOS determines how much extended memory is present during the POST.

This is the amount of memory located above 1 MB in the CPU's memory address map.



## 2-2 Advanced BIOS Features

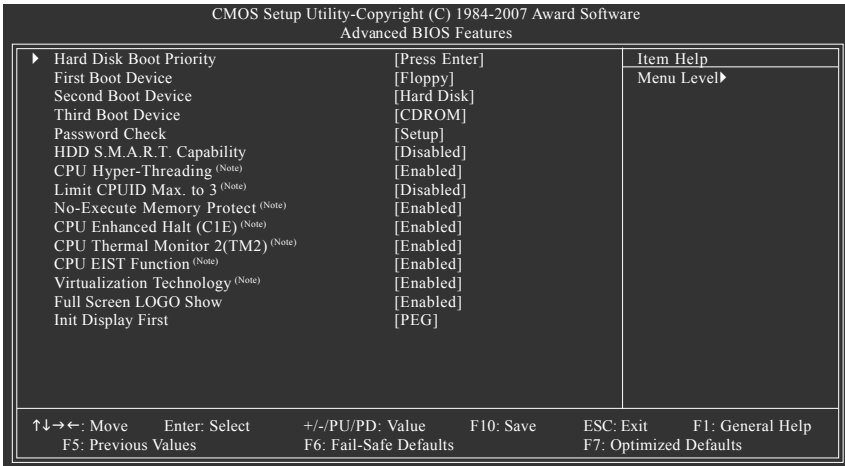

### ☞ Hard Disk Boot Priority

Select boot sequence for onboard(or add-on cards) SCSI, RAID, etc.

Use <↑> or <↓> to select a device, then press<+> to move it up, or <-> to move it down the list. Press <ESC> to exit this menu.

### ☞ First / Second / Third Boot Device

- ▶ Floppy            Select your boot device priority by Floppy.
- ▶ LS120            Select your boot device priority by LS120.
- ▶ Hard Disk        Select your boot device priority by Hard Disk.
- ▶ CDROM            Select your boot device priority by CDROM.
- ▶ ZIP                Select your boot device priority by ZIP.
- ▶ USB-FDD         Select your boot device priority by USB-FDD.
- ▶ USB-ZIP          Select your boot device priority by USB-ZIP.
- ▶ USB-CDROM      Select your boot device priority by USB-CDROM.
- ▶ USB-HDD         Select your boot device priority by USB-HDD.
- ▶ Legacy LAN      Select your boot device priority by Legacy LAN.
- ▶ Disabled         Disable this function.

### ☞ Password Check

- ▶ Setup            The system will boot but will not access to Setup page if the correct password is not entered at the prompt. (Default value)
- ▶ System          The system will not boot and will not access to Setup page if the correct password is not entered at the prompt.

(Note) This item will show up when you install a processor that supports this function.

### ☞ **HDD S.M.A.R.T. Capability**

This feature allows your hard disk to report read/write errors and to issue warnings when third-party hardware monitor utility is installed.

- ▶▶ Enabled      Enable HDD S.M.A.R.T. capability.
- ▶▶ Disabled      Disable HDD S.M.A.R.T. capability. (Default value)

### ☞ **CPU Hyper-Threading** <sup>(Note)</sup>

- ▶▶ Enabled      Enable CPU Hyper Threading Feature. Please note that this feature is only working for operating system with multi processors mode supported. (Default value)
- ▶▶ Disabled      Disable CPU Hyper Threading.

### ☞ **Limit CPUID Max. to 3** <sup>(Note)</sup>

- ▶▶ Enabled      Limit CPUID Maximum value to 3 when use older OS like NT4.
- ▶▶ Disabled      Disable CPUID Limit for windows XP. (Default value)

### ☞ **No-Execute Memory Protect** <sup>(Note)</sup>

- ▶▶ Enabled      Enable No-Execute Memory Protect function. (Default value)
- ▶▶ Disabled      Disable No-Execute Memory Protect function.

### ☞ **CPU Enhanced Halt (C1E)** <sup>(Note)</sup>

- ▶▶ Enabled      Enable CPU Enhanced Halt (C1E) function. (Default value)
- ▶▶ Disabled      Disable CPU Enhanced Halt (C1E) function.

### ☞ **CPU Thermal Monitor 2 (TM2)** <sup>(Note)</sup>

- ▶▶ Enabled      Enable CPU Thermal Monitor 2 (TM2) function. (Default value)
- ▶▶ Disabled      Disable CPU Thermal Monitor 2 (TM2) function.

### ☞ **CPU EIST Function** <sup>(Note)</sup>

- ▶▶ Enabled      Enable CPU EIST function. (Default value)
- ▶▶ Disabled      Disable CPU EIST function.

### ☞ **Virtualization Technology** <sup>(Note)</sup>

- ▶▶ Enabled      Enable Virtualization Technology function. (Default value)
- ▶▶ Disabled      Disable Virtualization Technology function.

### ☞ **Full Screen LOGO Show**

- ▶▶ Enabled      Show full screen logo at system startup. (Default value)
- ▶▶ Disabled      Disable this function. If you wish to see BIOS POST screen, set this item to "Disabled".

### ☞ **Init Display First**

This feature allows you to select the first initiation of the monitor display from which card when you install a PCI card and a PCI Express VGA card on the motherboard.

- ▶▶ PCI            Set Init Display First to PCI VGA card.
- ▶▶ PEG           Set Init Display First to PCI Express VGA card (the PCIE\_16\_1 slot). (Default value)
- ▶▶ PEG(Slot2)   Set Init Display First to PCI Express VGA card (the PCIE\_8 slot).
- ▶▶ PEG(Slot3)   Set Init Display First to PCI Express VGA card (the PCIE\_16\_2 slot).

(Note) This item will show up when you install a processor that supports this function.

## 2-3 Integrated Peripherals

CMOS Setup Utility-Copyright (C) 1984-2007 Award Software  
Integrated Peripherals

On-Chip IDE Channel0	[Enabled]	↑ ↓	Item Help
IDE Prefetch Mode	[Enabled]		Menu Level▶
NV Serial-ATA Controller	[All Enabled]		
▶ Serial-ATA RAID Config	[Press Enter]		
Onboard SATA-II Ctrl1	[Enabled]		
Onboard SATA-II Ctrl1 Mode	[IDE]		
Onboard SATA-II Ctrl2	[Enabled]		
Onboard SATA-II Ctrl2 Mode	[IDE]		
On-Chip MAC Lan	[Auto]		
On-Chip MAC1 Lan	[Auto]		
▶ On-Chip SMART LAN	[Press Enter]		
Onboard LAN1 Controller	[Enabled]		
Onboard LAN2 Controller	[Enabled]		
Onboard LAN Boot ROM	[Disabled]		
Onboard Audio Function	[Auto]		
On-Chip USB	[V1.1+V2.0]		
USB Keyboard Support	[Disabled]		
USB Mouse Support	[Disabled]		
Onboard 1394	[Enabled]		

↑↓→←: Move    Enter: Select    +/-/PU/PD: Value    F10: Save    ESC: Exit    F1: General Help  
F5: Previous Values    F6: Fail-Safe Defaults    F7: Optimized Defaults

CMOS Setup Utility-Copyright (C) 1984-2007 Award Software  
Integrated Peripherals

Legacy USB storage detect	[Enabled]	↑ ↓	Item Help
Onboard Serial Port 1	[3F8/IRQ4]		Menu Level▶
Onboard Parallel Port	[378/IRQ7]		
Parallel Port Mode	[SPP]		
x ECP Mode Use DMA	3		

↑↓→←: Move    Enter: Select    +/-/PU/PD: Value    F10: Save    ESC: Exit    F1: General Help  
F5: Previous Values    F6: Fail-Safe Defaults    F7: Optimized Defaults

### ☞ On-Chip IDE Channel0

- ▶▶ Enabled Enable onboard 1st channel IDE port. (Default value)
- ▶▶ Disabled Disable onboard 1st channel IDE port.

### ☞ IDE Prefetch Mode

- ▶▶ Enabled Enable IDE data buffer to enhance HDD transfer speed. (Default value)
- ▶▶ Disabled Disable IDE data buffer for the system stability.

### ☞ NV Serial-ATA Controller

- ▶▶ All Enabled Enable NV Serial-ATA Controller function. (Default value)
- ▶▶ SATA-1 Enable NV SATA-1 function.
- ▶▶ SATA-1+2 Enable NV SATA-1+2 function
- ▶▶ Disabled Disable this function.

### ☞ Serial-ATA RAID Config

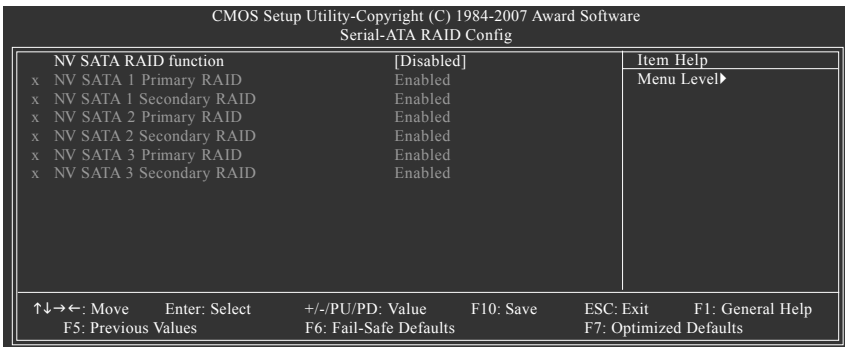

### ☞ NV SATA RAID function

- ▶▶ Enabled Enable NV SATA RAID function.
- ▶▶ Disabled Disable NV SATA RAID function. (Default value)

### ☞ NV SATA 1 Primary RAID

- ▶▶ Enabled Enable NV SATA 1 primary RAID function.
- ▶▶ Disabled Disable this function. (Default value)

### ☞ NV SATA 1 Secondary RAID

- ▶▶ Enabled Enable NV SATA 1 secondary RAID function.
- ▶▶ Disabled Disable this function. (Default value)

### ☞ NV SATA 2 Primary RAID

- ▶▶ Enabled Enable NV SATA 2 primary RAID function.
- ▶▶ Disabled Disable this function. (Default value)

### ☞ NV SATA 2 Secondary RAID

- ▶▶ Enabled Enable NV SATA 2 secondary RAID function.
- ▶▶ Disabled Disable this function. (Default value)

### ☞ **NV SATA 3 Primary RAID**

- ▶▶ Enabled      Enable NV SATA 3 primary RAID function.
- ▶▶ Disabled     Disable this function. (Default value)

### ☞ **NV SATA 3 Secondary RAID**

- ▶▶ Enabled      Enable NV SATA 3 secondary RAID function.
- ▶▶ Disabled     Disable this function. (Default value)

### ☞ **Onboard SATA-II Ctrl1 (GSATAII1-0 / GSATAII1-1 connectors)**

- ▶▶ Enabled      Enable onboard SATA-II ctrl1 function. (Default value)
- ▶▶ Disabled     Disable onboard SATA-II ctrl1 function.

### ☞ **Onboard SATA-II Ctrl1 Mode**

This function allows users to decide the operating mode of the SATA-II Ctrl1 (GSATAII1-0 / GSATAII1-1) ports controlled by the Gigabyte SATA2 controller.

- ▶▶ IDE            Set the SATA-II Ctrl1 channel to IDE mode. (Default value)
- ▶▶ AHCI         Set the SATA-II Ctrl1 channel to AHCI mode. Advanced Host Controller Interface (AHCI) is an interface specification that allows the storage driver to enable advanced Serial ATA features such as Native Command Queuing and hot plug. For more details about AHCI, please visit Intel's website.
- ▶▶ RAID         Set the SATA-II Ctrl1 channel to RAID mode.

### ☞ **Onboard SATA-II Ctrl2 (GSATAII2-0 / GSATAII2-1 connectors)**

- ▶▶ Enabled      Enable onboard SATA-II ctrl2 function. (Default value)
- ▶▶ Disabled     Disable onboard SATA-II ctrl2 function.

### ☞ **Onboard SATA-II Ctrl2 Mode**

This function allows users to decide the operating mode of the SATA-II Ctrl2 (GSATAII2-0 / GSATAII2-1)

ports controlled by the Gigabyte SATA2 controller.

- ▶▶ IDE            Set the SATA-II Ctrl2 channel to IDE mode. (Default value)
- ▶▶ AHCI         Set the SATA-II Ctrl2 channel to AHCI mode. Advanced Host Controller Interface (AHCI) is an interface specification that allows the storage driver to enable advanced Serial ATA features such as Native Command Queuing and hot plug. For more details about AHCI, please visit Intel's website.
- ▶▶ RAID         Set the SATA-II Ctrl2 channel to RAID mode.

### ☞ **On-Chip MAC Lan (LAN1)**

- ▶▶ Auto          Auto-detect onboard LAN chip function. (Default value)
- ▶▶ Disabled     Disable onboard LAN chip function.

### ☞ **On-Chip MAC1 Lan (LAN2)**

- ▶▶ Auto          Auto-detect onboard LAN1 chip function. (Default value)
- ▶▶ Disabled     Disable onboard LAN1 chip function.

## ☞ On-Chip SMART LAN (LAN Cable Diagnostic Function) (For LAN1/LAN2)

CMOS Setup Utility-Copyright (C) 1984-2007 Award Software		Item Help
SMART LAN		Menu Level▶
Start detecting at Port 0.		
Pair1-2 Status = Normal	/ Length = N/A	
Pair3-6 Status = Normal	/ Length = N/A	
Pair4-5 Status = Normal	/ Length = N/A	
Pair7-8 Status = Normal	/ Length = N/A	
Start detecting at Port 1.		
Pair1-2 Status = Normal	/ Length = N/A	
Pair3-6 Status = Normal	/ Length = N/A	
Pair4-5 Status = Normal	/ Length = N/A	
Pair7-8 Status = Normal	/ Length = N/A	
↑↓→←: Move    Enter: Select		F10: Save
F5: Previous Values		ESC: Exit    F1: General Help
+/-/PU/PD: Value		F7: Optimized Defaults
F6: Fail-Safe Defaults		

This motherboard incorporates cable diagnostic feature designed to detect the status of the attached LAN cable. This feature will detect cabling issue and report the approximate distance to the fault or short. Refer to the following information for diagnosing your LAN cable:

### ▶▶ When LAN Cable Is Functioning Normally...

1. If no cable problem is detected on the LAN cable connected to a Gigabit hub, the **Status** fields of Pair 1-2, Pair 3-6, Pair 4-5, and Pair 7-8 will show **Normal** and the **Length** fields will show **N/A**, as shown in the figure above.
2. If no cable problem is detected on the LAN cable connected to a 10/100 Mbps hub, the **Status** fields of Pair 1-2 and Pair 3-6 will show **Normal** and the **Length** fields will show **N/A**. However, because Pair 4-5 and Pair 7-8 are not used in a 10/100 Mbps environment, their **Status** fields will show **Short** or **Open**, and the length shown is the approximate length of the attached LAN cable.

### ▶▶ When a Cable Problem Occurs...

If a cable problem occurs on a specified pair of wires, the **Status** field will show **Short** or **Open** and the length shown will be the approximate distance to the fault or short. For example, if it shows `Pair1-2 Status = Short / Length = 1.6m`, it means that a fault or short might occur at about 1.6m on Pair 1-2.

### ▶▶ When No LAN Cable Is Attached...

If no LAN cable is attached to the motherboard, the **Status** fields of all four pairs of wires will show **Open**.

- ☞ **Onboard LAN1 Controller (The upper LAN connector of the back panel Dual LAN connectors)**
  - ▶▶ Enabled Enable onboard LAN1 controller function. (Default value)
  - ▶▶ Disabled Disable onboard LAN1 controller function.
- ☞ **Onboard LAN2 Controller (The lower LAN connector of the back panel Dual LAN connectors)**
  - ▶▶ Enabled Enable onboard LAN2 controller function. (Default value)
  - ▶▶ Disabled Disable onboard LAN2 controller function.
- ☞ **Onboard LAN Boot ROM**

This function decide whether to invoke the boot ROM of the onboard LAN chip.

  - ▶▶ Enabled Enable this function.
  - ▶▶ Disabled Disable this function. (Default value)
- ☞ **Onboard Audio Function**
  - ▶▶ Auto Auto-detect onboard audio function. (Default value)
  - ▶▶ Disabled Disable this function.
- ☞ **On-Chip USB**
  - ▶▶ V1.1+V2.0 Enable the USB 1.1 and USB 2.0 controllers. (Default value)
  - ▶▶ V1.1 Enable only the USB 1.1 controller.
  - ▶▶ Disabled Disable the onboard USB controller.
- ☞ **USB Keyboard Support**
  - ▶▶ Enabled Enable USB keyboard support.
  - ▶▶ Disabled Disable USB keyboard support. (Default value)
- ☞ **USB Mouse Support**
  - ▶▶ Enabled Enable USB mouse support.
  - ▶▶ Disabled Disable USB mouse support. (Default value)
- ☞ **Onboard 1394**
  - ▶▶ Enabled Enable onboard IEEE 1394 function. (Default value)
  - ▶▶ Disabled Disable this function.
- ☞ **Legacy USB storage detect**

This option allows users to decide whether to detect USB storage devices, including USB flash drives and USB hard drives during POST.

  - ▶▶ Enabled BIOS will scan all USB storage devices. (Default value)
  - ▶▶ Disabled Disable this function.
- ☞ **Onboard Serial Port 1**
  - ▶▶ Auto BIOS will automatically setup the port 1 address.
  - ▶▶ 3F8/IRQ4 Enable onboard Serial port 1 and address is 3F8/IRQ4. (Default value)
  - ▶▶ 2F8/IRQ3 Enable onboard Serial port 1 and address is 2F8/IRQ3.
  - ▶▶ 3E8/IRQ4 Enable onboard Serial port 1 and address is 3E8/IRQ4.
  - ▶▶ 2E8/IRQ3 Enable onboard Serial port 1 and address is 2E8/IRQ3.
  - ▶▶ Disabled Disable onboard Serial port 1.

### 🔑 **Onboard Parallel Port**

- ▶▶ Disabled      Disable onboard LPT port.
- ▶▶ 378/IRQ7      Enable onboard LPT port and address is 378/IRQ7. (Default value)
- ▶▶ 278/IRQ5      Enable onboard LPT port and address is 278/IRQ5.
- ▶▶ 3BC/IRQ7      Enable onboard LPT port and address is 3BC/IRQ7.

### 🔑 **Parallel Port Mode**

- ▶▶ SPP            Using Parallel port as Standard Parallel Port. (Default value)
- ▶▶ EPP            Using Parallel port as Enhanced Parallel Port.
- ▶▶ ECP            Using Parallel port as Extended Capabilities Port.
- ▶▶ ECP+EPP      Using Parallel port as ECP & EPP mode.

### 🔑 **ECP Mode Use DMA**

This option is available only when **Parallel Port Mode** is set to ECP or ECP+EPP.

- ▶▶ 3              Set ECP Mode Use DMA to 3. (Default value)
- ▶▶ 1              Set ECP Mode Use DMA to 1.



## 2-4 Power Management Setup

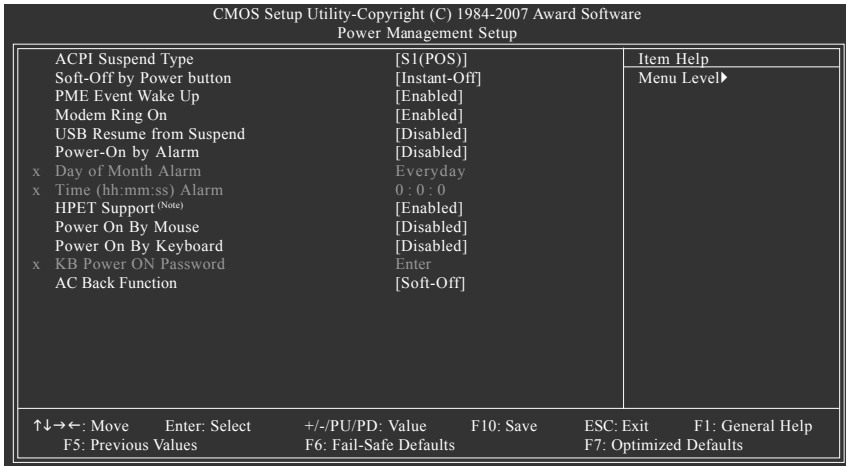

### ☞ ACPI Suspend Type

- ▶▶ S1(POS)    Set ACPI suspend type to S1/POS(Power On Suspend). (Default value)
- ▶▶ S3(STR)    Set ACPI suspend type to S3/STR(Suspend To RAM).

### ☞ Soft-Off by Power button

- ▶▶ Instant-Off    Press power button then Power off instantly. (Default value)
- ▶▶ Delay 4 Sec.    Press power button 4 seconds to Power off. Enter suspend if button is pressed less than 4 seconds.

### ☞ PME Event Wake Up

- ▶▶ Disabled    Disable this function.
- ▶▶ Enabled    Enable PME Event Wake up. (Default value)

### ☞ Modem Ring On

An incoming call via modem can awake the system from any suspend state.

- ▶▶ Disabled    Disable this function.
- ▶▶ Enabled    Enable Modem Ring On function. (Default value)

### ☞ USB Resume from Suspend

- ▶▶ Disabled    Disable this function. (Default value)
- ▶▶ Enabled    Enable USB device wake up system from suspend mode.

### ☞ Power-On by Alarm

You can enable the "Power-On by Alarm" item and key in Date/Time to power on system.

- ▶▶ Disabled    Disable this function. (Default value)
- ▶▶ Enabled    Enable alarm function to POWER ON system.

If Power-On by Alarm is Enabled.

- ▶▶ Day of Month Alarm :    Everyday, 1~31
- ▶▶ Time (hh: mm: ss) Alarm : (0~23) : (0~59) : (0~59)

(Note) Supported on Vista operating system only.

☞ **HPET Support** <sup>(Note)</sup>

- ▶▶ Disabled      Disable this function.
- ▶▶ Enabled      Enable support for High Precision Event Timer (HPET) function. (Default value)

☞ **Power On By Mouse**

- ▶▶ Disabled      Disable this function. (Default value)
- ▶▶ Double-Click    Double click on PS/2 mouse left button to power on the system.

☞ **Power On By Keyboard**

- ▶▶ Disabled      Disable this function. (Default value)
- ▶▶ Keyboard 98    If your keyboard have "POWER Key" button, you can press the key to power on the system.
- ▶▶ Any KEY      Press any key to power on the system.
- ▶▶ Password      Enter from 1 to 5 characters to set the Keyboard Power On Password.

☞ **KB Power ON Password**

When "Power On by Keyboard" is set to Password, you can set the password here.

- ▶▶ Enter          Input password (from 1 to 5 characters) and press Enter to set the Keyboard Power On password.

☞ **AC Back Function**

- ▶▶ Soft-Off      When AC-power back to the system, the system will be in "Off" state. (Default value)
- ▶▶ Full-On      When AC-power back to the system, the system always in "On" state.

(Note) Supported on Vista operating system only.

## 2-5 PnP/PCI Configurations

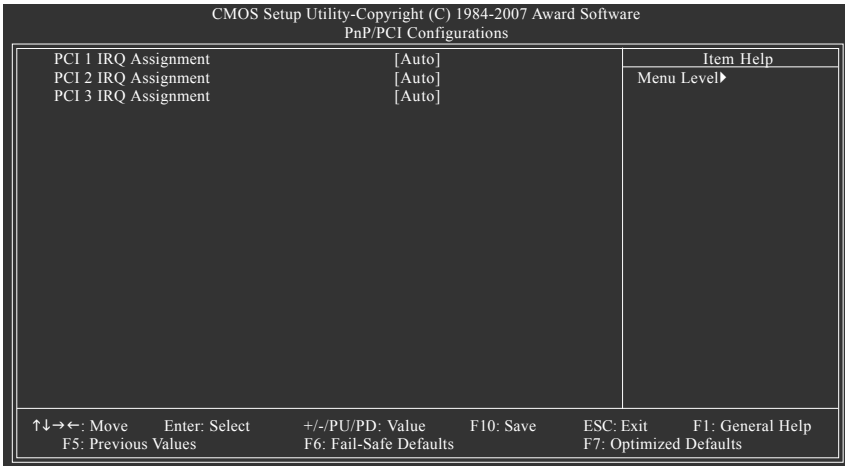

### ☞ PCI 1 IRQ Assignment

- ▶▶ Auto                      Auto assign IRQ to PCI 1. (Default value)
- ▶▶ 3,4,5,7,9,10,11,12,14,15    Set IRQ 3,4,5,7,9,10,11,12,14,15 to PCI 1.

### ☞ PCI 2 IRQ Assignment

- ▶▶ Auto                      Auto assign IRQ to PCI 2. (Default value)
- ▶▶ 3,4,5,7,9,10,11,12,14,15    Set IRQ 3,4,5,7,9,10,11,12,14,15 to PCI 2.

### ☞ PCI 3 IRQ Assignment

- ▶▶ Auto                      Auto assign IRQ to PCI 3. (Default value)
- ▶▶ 3,4,5,7,9,10,11,12,14,15    Set IRQ 3,4,5,7,9,10,11,12,14,15 to PCI 3.

## 2-6 PC Health Status

CMOS Setup Utility-Copyright (C) 1984-2007 Award Software		Item Help
PC Health Status		Menu Level ▶
Reset Case Open Status	[Disabled]	
Case Opened	Yes	
Vcore	OK	
DDR2 1.8V	OK	
+3.3V	OK	
+12V	OK	
Current System Temperature	32°C	
Current CPU Temperature	45°C	
Current CPU FAN Speed	3245 RPM	
Current SYSTEM FAN Speed	0 RPM	
Current POWER FAN Speed	0 RPM	
CPU Warning Temperature	[Disabled]	
CPU FAN Fail Warning	[Disabled]	
SYSTEM FAN Fail Warning	[Disabled]	
POWER FAN Fail Warning	[Disabled]	
CPU Smart FAN Control	[Enabled]	
CPU Smart FAN Mode	[Auto]	
System Smart FAN Control	[Enabled]	

↑↓→←: Move    Enter: Select    +/-/PU/PD: Value    F10: Save    ESC: Exit    F1: General Help  
 F5: Previous Values    F6: Fail-Safe Defaults    F7: Optimized Defaults

### Reset Case Open Status

- ▶ Disabled      Don't reset case open status. (Default value)
- ▶ Enabled      Clear case open status at next boot.

### Case Opened

If the case is closed, **Case Opened** will show "No."

If the case is opened, **Case Opened** will show "Yes."

If you want to reset **Case Opened** value, enable **Reset Case Open Status** and save the change to CMOS, and then your computer will restart.

### Current Voltage(V) Vcore / DDR2 1.8V / +3.3V / +12V

- ▶ Detect system's voltage status automatically.

### Current System/CPU Temperature

- ▶ Detect system/CPU temperature automatically.

### Current CPU/SYSTEM/POWER FAN Speed (RPM)

- ▶ Detect CPU/system/power fan speed status automatically.

### CPU Warning Temperature

- ▶ 60°C / 140°F      Monitor CPU temperature at 60°C / 140°F.
- ▶ 70°C / 158°F      Monitor CPU temperature at 70°C / 158°F.
- ▶ 80°C / 176°F      Monitor CPU temperature at 80°C / 176°F.
- ▶ 90°C / 194°F      Monitor CPU temperature at 90°C / 194°F.
- ▶ Disabled          Disable this function. (Default value)

### CPU/SYSTEM/POWER FAN Fail Warning

- ▶ Disabled          Disable CPU/system/power fan fail warning function. (Default value)
- ▶ Enabled          Enable CPU/system/power fan fail warning function.

### ☞ CPU Smart FAN Control<sup>(Note)</sup>

- ▶▶ Disabled            Disable this function.
- ▶▶ Enabled            When this function is enabled, CPU fan will run at different speed depending on CPU temperature. Users can adjust the fan speed with Easy Tune based on their requirements. (Default value)

### ☞ CPU Smart FAN Mode

This option is available only when CPU Smart FAN Control is enabled.

- ▶▶ Auto                BIOS autodetects the type of CPU fan you installed and sets the optimal CPU Smart FAN control mode for it. (Default value)
- ▶▶ Voltage            Set to Voltage when you use a CPU fan with a 3-pin fan power cable.
- ▶▶ PWM                Set to PWM when you use a CPU fan with a 4-pin fan power cable.

### ☞ System Smart FAN Control

- ▶▶ Disabled            Disable this function. (Default value)
- ▶▶ Enabled            When this function is enabled, system fan will run at different speed depending on system temperature. Users can adjust the fan speed with Easy Tune based on their requirements.

(Note) Whether the CPU Smart FAN Control function is supported will depend on the CPU you install.

## 2-7 MB Intelligent Tweaker(M.I.T.)

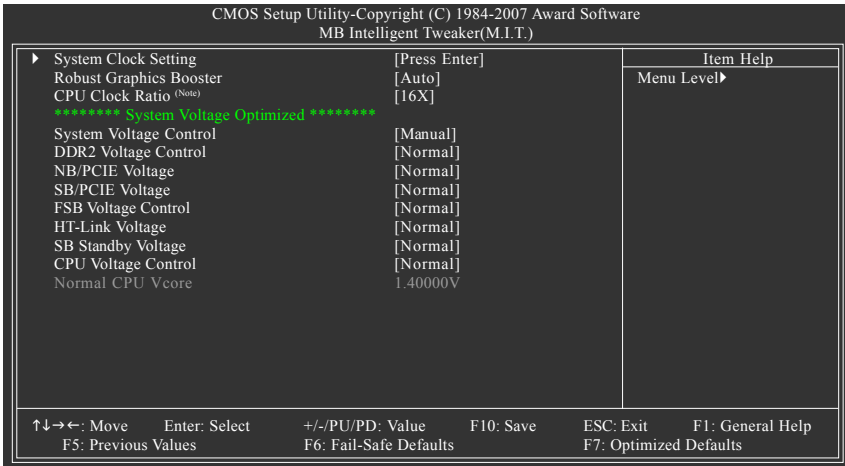

Incorrectly using these features may result in system instability or corruption.

Doing an overclock or overvoltage on CPU, chipsets and memory modules may result in damages or shortened life expectancy to these components.

Please be aware that the M.I.T. menu items are for power users only.

### System Clock Setting

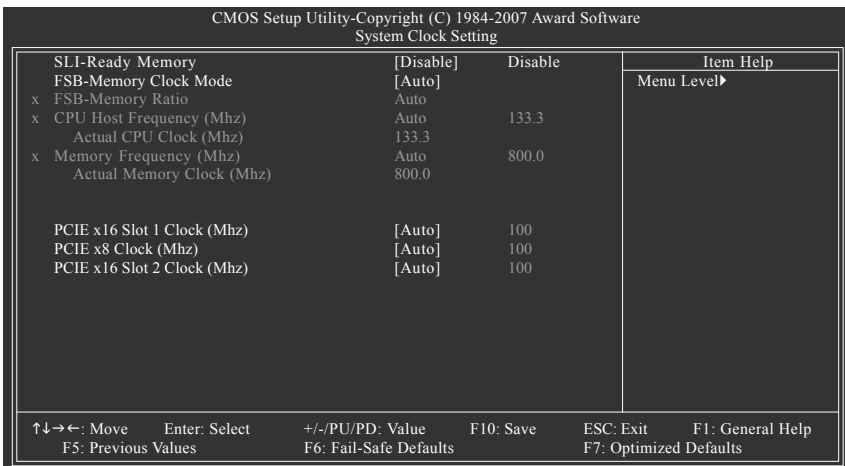

(Note) This item will show up when you install a processor that supports this function.

### ☞ **SLI-Ready Memory**

Allows you to use SLI-ready memory. The option is configurable only when SLI-ready memory is used.

Options: Disable, CPUOC 0%~CPUOC 5%, CPUOC MAX and Expert

### ☞ **FSB-Memory Clock Mode**

- ▶▶ Auto BIOS will automatically setup the FSB-Memory Clock Mode. (Default value)
- ▶▶ Linked Set FSB-Memory Clock Mode to Linked.
- ▶▶ Unlinked Set FSB-Memory Clock Mode to Unlinked.

### ☞ **FSB-Memory Ratio**

This option is available only when FSB-Memory Clock Mode is Linked.

- ▶▶ Auto BIOS will automatically setup the FSB-Memory Ratio. (Default value)
- ▶▶ 1:1 Set FSB-Memory Ratio to 1:1.
- ▶▶ 5:4 Set FSB-Memory Ratio to 5:4.
- ▶▶ 3:2 Set FSB-Memory Ratio to 3:2.
- ▶▶ Sync Mode Set FSB-Memory Ratio to Sync Mode.

### ☞ **CPU Host Frequency**

This option is available only when FSB-Memory Clock Mode is Linked or Unlinked.

- ▶▶ 100 ~ 650 Set CPU Host Frequency from 100 MHz to 650 MHz.

The actual range depends on the CPU you install.

If you use a 533 MHz FSB processor, please set **CPU Host Frequency** to **133 MHz**.

If you use an 800 MHz FSB processor, please set **CPU Host Frequency** to **200 MHz**.

If you use a 1066 MHz FSB processor, please set **CPU Host Frequency** to **266 MHz**.

If you use a 1333 MHz FSB processor, please set **CPU Host Frequency** to **333 MHz**.

### ☞ **Actual CPU Clock (Mhz)**

The values depend on **CPU Host Frequency** setting.

### ☞ **Memory Frequency (Mhz)**

This option is available only when FSB-Memory Clock Mode is Unlinked.

- ▶▶ 400 ~ 1400 Set Memory Frequency from 400 MHz to 1400 MHz.

### ☞ **Actual Memory Clock (Mhz)**

The values depend on Memory Frequency setting.

### ☞ **PCIe x16 Slot 1 Clock (Mhz)**

- ▶▶ Auto BIOS will automatically setup the PCIe x16 Slot 1 Clock. (Default value)
- ▶▶ 100 ~ 150 Set PCIe x16 Slot 1 Clock from 100 Mhz to 150 Mhz.

### ☞ **PCIe x8 Clock (Mhz)**

- ▶▶ Auto BIOS will automatically setup the PCIe x8 Clock. (Default value)
- ▶▶ 100 ~ 150 Set PCIe x8 Clock from 100 Mhz to 150 Mhz.

### ☞ **PCIe x16 Slot 2 Clock (Mhz)**

- ▶▶ Auto BIOS will automatically setup the PCIe x16 Slot 2 Clock. (Default value)
- ▶▶ 100 ~ 150 Set PCIe x16 Slot 2 Clock from 100 Mhz to 150 Mhz.

### ☞ **Robust Graphics Booster**

Select the options can enhance the VGA graphics card bandwidth to get higher performance.

- ▶▶ Auto                      Set Robust Graphics Booster to Auto. (Default value)
- ▶▶ Fast                      Set Robust Graphics Booster to Fast.
- ▶▶ Turbo                     Set Robust Graphics Booster to Turbo.

### ☞ **CPU Clock Ratio** (Note)

This setup option will automatically assign by CPU detection.

The option will display "Locked" and read only if the CPU ratio is not changeable.

### ☞ **System Voltage Control**

Determines whether to manually set the system voltages. **Auto** lets BIOS automatically set the system voltages as required. **Manual** allows all voltage control items below to be configurable. (Default: Manual)

### ☞ **DDR2 Voltage Control**

Please note that by overclocking your system through the increase of the DDR2 voltage, damage to the memory may occur.

- ▶▶ Supports adjustable DDR2 voltage from 1.825V to 2.575V. (Default value: Normal)

### ☞ **NB/PCIE Voltage**

Set the voltage settings for Northbridge, its PCI Express bus voltage.

- ▶▶ Normal                    Set NB/PCIE voltage to Normal. (Default value)
- ▶▶ +0.05V~+0.20V        Set NB/PCIE voltage to +0.05V~+0.20V.

### ☞ **SB/PCIE Voltage**

Set the voltage settings for Southbridge, its PCI Express bus voltage.

- ▶▶ Normal                    Supply SB/PCIE voltage as Chipset requires. (Default value)
- ▶▶ +0.05V~+0.55V        Set SB/PCIE voltage to +0.05V~+0.55V.

### ☞ **FSB Voltage Control**

▶▶ Normal                    Supply FSB voltage as FSB required. (Default value)

- ▶▶ +0.05V ~ +0.35V      Increase FSB voltage by 0.05V to 0.35V.

### ☞ **HT-Link Voltage**

Set the voltage settings for the HT-Link between Southbridge and Northbridge.

- ▶▶ Normal                    Supply HT-Link voltage as HT-Link requires. (Default value)
- ▶▶ +0.05V~+0.35V        Set HT-Link voltage to +0.05V~+0.35V.

### ☞ **SB Standby Voltage**

Set the Southbridge standby voltage.

- ▶▶ Normal                    Supply standby voltage as Southbridge requires. (Default value)
- ▶▶ +0.10V~+0.20V        Set Southbridge standby voltage to +0.10V~+0.20V.

### ☞ **CPU Voltage Control**

▶▶ Supports adjustable CPU vcore. The adjustable range is dependent on CPUs. (Default value: Normal)

Please note that by overclocking your system through the increase of the CPU voltage, damage to the CPU or decrease in the CPU life expectancy may occur.

### ☞ **Normal CPU Vcore**

- ▶▶ Display your CPU's normal voltage.



## 2-8 Load Fail-Safe Defaults

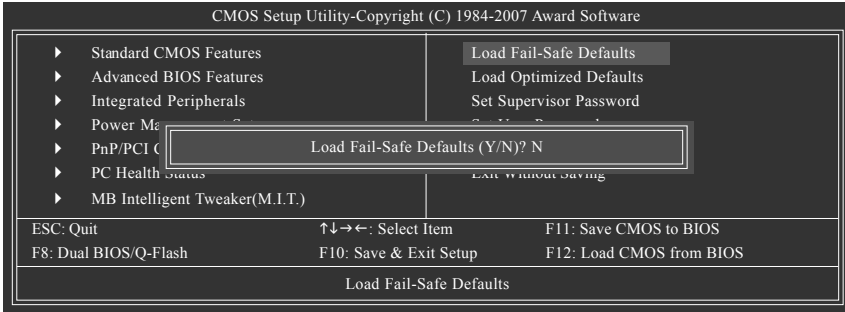

Fail-Safe defaults contain the most appropriate values of the system parameters that allow minimum system performance.

## 2-9 Load Optimized Defaults

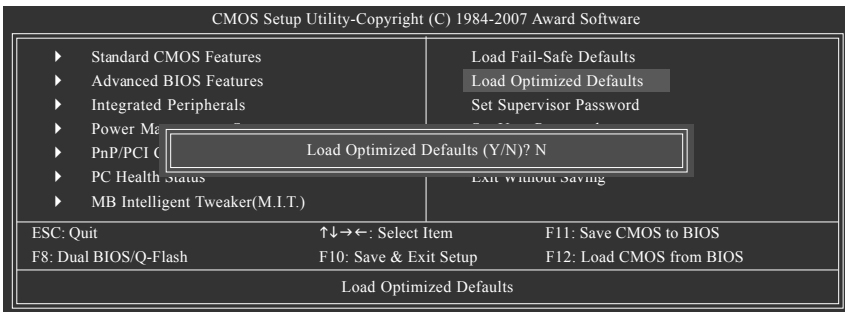

Selecting this field loads the factory defaults for BIOS and Chipset Features which the system automatically detects.

## 2-10 Set Supervisor/User Password

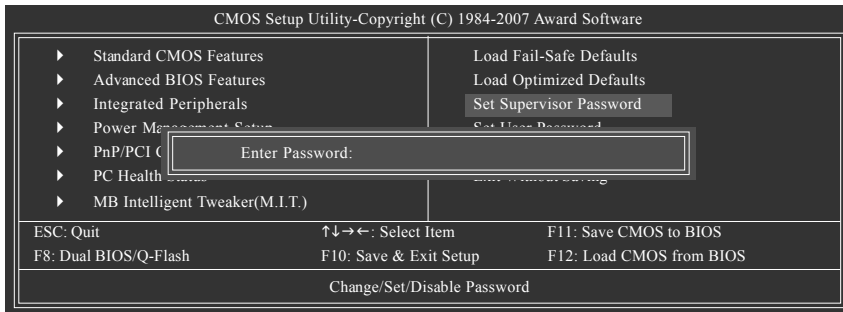

When you select this function, the following message will appear at the center of the screen to assist you in creating a password.

Type the password, up to eight characters, and press <Enter>. You will be asked to confirm the password. Type the password again and press <Enter>. You may also press <Esc> to abort the selection and not enter a password.

To disable password, just press <Enter> when you are prompted to enter password. A message "PASSWORD DISABLED" will appear to confirm the password being disabled. Once the password is disabled, the system will boot and you can enter Setup freely.

The BIOS Setup program allows you to specify two separate passwords:

SUPERVISOR PASSWORD and a USER PASSWORD. When disabled, anyone may access all BIOS Setup program function. When enabled, the Supervisor password is required for entering the BIOS Setup program and having full configuration fields, the User password is required to access only basic items.

If you select "System" at "Password Check" in Advance BIOS Features Menu, you will be prompted for the password every time the system is rebooted or any time you try to enter Setup Menu.

If you select "Setup" at "Password Check" in Advance BIOS Features Menu, you will be prompted only when you try to enter Setup.

## 2-11 Save & Exit Setup

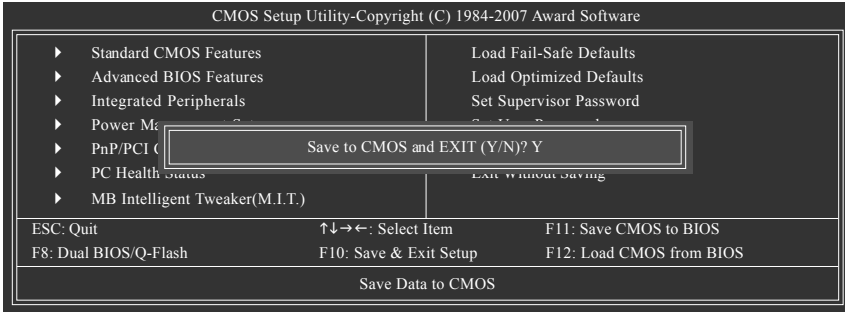

Type "Y" will quit the Setup Utility and save the user setup value to RTC CMOS.  
Type "N" will return to Setup Utility.

## 2-12 Exit Without Saving

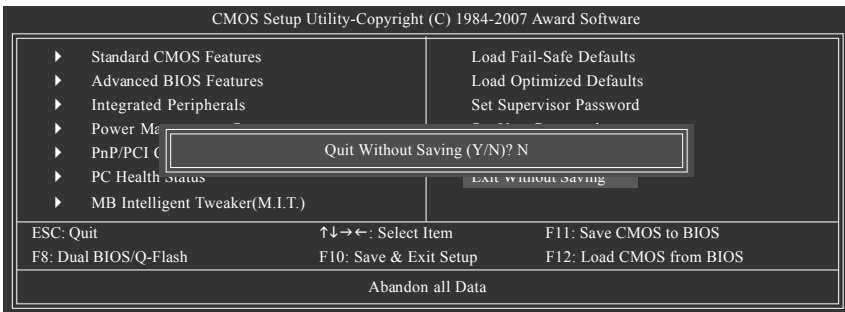

Type "Y" will quit the Setup Utility without saving to RTC CMOS.  
Type "N" will return to Setup Utility.



## Chapter 3 Drivers Installation



Pictures below are shown in Windows XP.

Insert the driver CD-title that came with your motherboard into your CD-ROM drive, the driver CD-title will auto start and show the installation guide. If not, please double click the CD-ROM device icon in "My computer", and execute the Run.exe.

### 3-1 Install Chipset Drivers

"Xpress Install " is now analyzing your computer...99%

After insert the driver CD, "Xpress Install" will scan automatically the system and then list all the drivers that recommended to install. Please pick the item that you want and press "install" followed the item; or you can press "Xpress Install" to install all items defaulted.

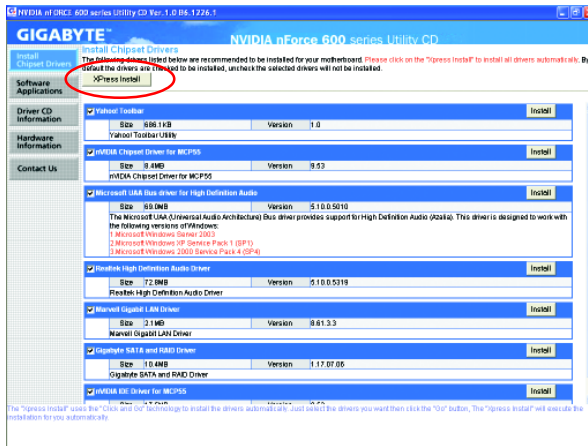

Some device drivers will restart your system automatically. After restarting your system the "Xpress Install" will continue to install other drivers.

System will reboot automatically after install the drivers, afterward you can install others application.



For USB2.0 driver support under Windows XP operating system, please use Windows Service Pack. After install Windows Service Pack, it will show a question mark "?" in "Universal Serial Bus controller" under "Device Manager". Please remove the question mark and restart the system (System will auto-detect the right USB2.0 driver).

## 3-2 Software Applications

This page displays all the tools that Gigabyte developed and some free software, you can choose anyone you want and press "install" to install them.

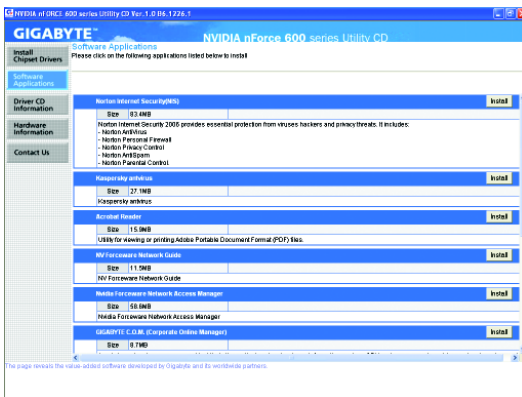

## 3-3 Driver CD Information

This page lists the contents of software and drivers in this CD-title.

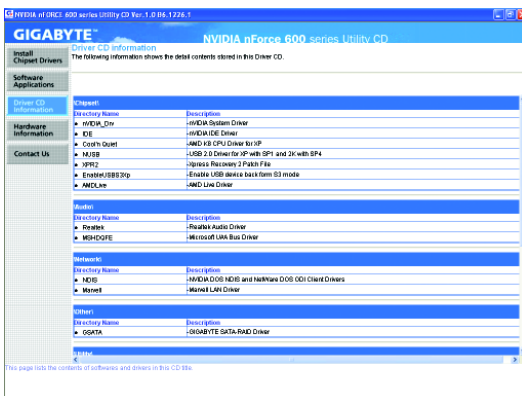

## 3-4 Hardware Information

This page lists all device you have for this motherboard.

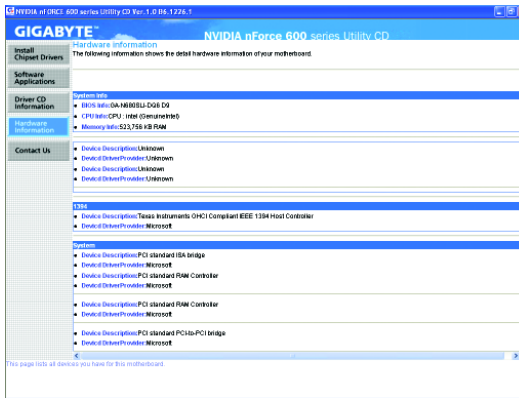

## 3-5 Contact Us

Please see the last page for details.







## Chapter 4 Appendix

### 4-1 Unique Software Utilities

(Not all model support these Unique Software Utilities, please check your MB features.)

#### 4-1-1 EasyTune 5 Introduction

EasyTune 5 presents the most convenient Windows based system performance enhancement and manageability utility. Featuring several powerful yet easy to use tools such as 1) Overclocking for enhancing system performance, 2) C.I.A. and M.I.B. for special enhancement for CPU and Memory, 3) Smart-Fan control for managing fan speed control of both CPU cooling fan and North-Bridge Chipset cooling fan, 4) PC health for monitoring system status. <sup>(Note)</sup>

#### User Interface Overview



	Button / Display	Description
1.	Overclocking	Enters the Overclocking setting page
2.	C.I.A. and M.I.B.	Enters the C.I.A. and M.I.B. setting page
3.	Smart-Fan	Enters the Smart-Fan setting page
4.	PC Health	Enters the PC Health setting page
5.	GO	Confirmation and Execution button
6.	"Easy Mode" & "Advance Mode"	Toggles between Easy and Advance Mode
7.	Display screen	Display panel of CPU frequency
8.	Function display LEDs	Shows the current functions status
9.	GIGABYTE Logo	Log on to GIGABYTE website
10.	Help button	Display EasyTune™ 5 Help file
11.	Exit or Minimize button	Quit or Minimize EasyTune™ 5 software

(Note) EasyTune 5 functions may vary depending on different motherboards.

## 4-1-2 Xpress Recovery2 Introduction



Xpress Recovery2 is designed to provide quick backup and restoration of hard disk data. Supporting Microsoft operating systems including Windows XP/2000/NT/98/Me and DOS, and file systems including FAT16, FAT32, and NTFS, Xpress Recovery2 is able to back up data on hard disks on PATA and SATA IDE controllers. After Xpress Recovery2 is executed from CD-ROM for the first time, it will stay permanent in your hard disk. If you wish to run Xpress Recovery2 later, you can simply press F9 during system bootup to enter Xpress Recovery2 without the CD-ROM.

### System requirements:

1. Intel x86 platforms
2. At least 64M bytes of system memory
3. VESA-supported VGA cards

### How to use the Xpress Recovery2

Initial access by booting from CD-ROM and subsequent access by pressing the F9 key:

Steps: After entering BIOS Setup, go to **Advanced BIOS Feature** and set to boot from CD-ROM. Save the settings and exit the BIOS Setup. Insert the provided driver CD into your CD-ROM drive. Upon system restart, the message which says "Boot from CD/DVD:" will appear in the bottom left corner of the screen. Press any key to enter Xpress Recovery2.

After the steps above are completed, subsequent access to Xpress Recovery2 can be made by simply pressing the <F9> key during system power-on.



1. If you have already entered Xpress Recovery2 by booting from the CD-ROM, you can enter Xpress Recovery2 by pressing the <F9> key in the future.
2. System storage capacity and the reading/writing speed of the hard disk will affect the data backup speed.
3. It is recommended that Xpress Recovery2 be immediately installed once you complete installations of OS and all required drivers as well as software.

## The Main Screen of Xpress Recovery2



### 1. RESTORE:

Restore the backed-up data to your hard disk. (This button will not appear if there is no backup file.)

### 2. BACKUP:

Back up data from hard disk.

### 3. REMOVE:

Remove previously-created backup files to release disk space.

(This button will not appear if there is no backup file.)

### 4. REBOOT:

Exit the main screen and restart the system.

### Limitations:

1. Not compatible to Xpress Recovery.
2. For the use of Xpress Recovery2, a primary partition must be reserved.
3. Xpress Recovery2 will store the backup file at the end of the hard disk, so free space available on the hard disk for the backup file must be allocated in advance. (A minimum 4GB is recommended but the actual space is dependent on the size of the data to be backed up)
4. Capable of backing up hard disks installed with Windows operating systems including DOS and Windows XP/2000/NT/9x/Me.
5. USB hard disks are currently not supported.
6. Does not support RAID/AHCI (class code 0104/0106) hard disks.
7. Capable of backing up and restoring only the first physical hard disk.

Hard disks detection sequence is as follows:

- a. PATA IDE primary channel
- b. PATA IDE secondary channel
- c. SATA IDE channel 1
- d. SATA IDE channel 2
- e. SATA IDE channel 3
- f. SATA IDE channel 4

### Precautions:

1. When using hard disks with more than 128 GB under Windows 2000, be sure to execute the EnableBigLba.exe program from the driver CD before data backup.
2. It is normal that data backup takes longer time than data restoration.
3. Xpress Recovery2 is compliant with the GPL regulations.
4. On a few motherboards based on Nvidia chipsets, BIOS update is required for Xpress Recovery2 to correctly identify RAID and SATA IDE mode. Please contact your motherboard manufacturer.



c. Dual BIOS Item explanation:

### **Wide Range Protection: Disable(Default), Enable**

Status 1:

If any failure (ex. Update ESCD failure, checksum error or reset? occurs in the Main BIOS, just before the Operating System is loaded and after the power is on, and that the Wide Range Protection is set to "Enable", the PC will boot from Backup BIOS automatically.

Status 2:

If the ROM BIOS on peripherals cards(ex. SCSI Cards, LAN Cards,..) emits signals to request restart of the system after the user make any alteration on it, the boot up BIOS will not be changed to the Backup BIOS.

### **Boot From : Main BIOS(Default), Backup BIOS**

Status 1:

The user can set to boot from Main BIOS or Backup BIOS.

Status 2:

If one of the Main BIOS or the Backup BIOS fails, this item "Boot From : Main BIOS(Default)" will become gray and will not be changed by user.

### **Auto Recovery : Enable(Default), Disable**

When one of the Main BIOS or Backup BIOS occurs checksum failure, the working BIOS will automatically recover the BIOS of checksum failure.

(In the Power Management Setup of the BIOS Setting, if ACPI Suspend Type is set to Suspend to RAM, the Auto Recovery will be set to Enable automatically.)

(If you want to enter the BIOS setting, please press "Del" key when the boot screen appears.)

### **Halt On Error : Disable(Default), Enable**

If the BIOS occurs a checksum error or the Main BIOS occurs a WIDE RANGE PROTECTION error and Halt On Error set to Enable, the PC will show messages on the boot screen, and the system will pause and wait for the user's instruction.

If Auto Recovery :Disable, it will show <or the other key to continue.>

If Auto Recovery :Enable, it will show <or the other key to Auto Recover.>

### **Keep DMI Data : Enable(Default), Disable**

Enable: The DMI data won't be replaced by flashing new BIOS.(recommend)

Disable: The DMI data will be replaced by flashing new BIOS.

### **Copy Main ROM Data to Backup**

(If you boot from Backup ROM, this item will change to Copy Backup ROM Data to Main)

Auto recovery message:

#### **BIOS Recovery: Main to Backup**

The means that the Main BIOS works normally and could automatically recover the Backup BIOS.

#### **BIOS Recovery: Backup to Main**

The means that the Backup BIOS works normally and could automatically recover the Main BIOS.

(This auto recovery utility is set by system automatically and can't be changed by user.)

### **Load Default Settings**

Load dual BIOS default value.

### **Save Settings to CMOS**

Save revised setting.



### Method 1 : Q-Flash™

Q-Flash™ is a BIOS update tool that allows the user to update BIOS without entering operating systems like MS-DOS or Windows. Embedded in the BIOS, the Q-Flash™ tool frees you from the hassles of

going through complicated BIOS flashing process.

#### Before Use:

Follow the steps below before using Q-Flash to update BIOS:

1. From GIGABYTE's website, download the latest compressed BIOS update file that matches your motherboard model
2. Extract the downloaded BIOS files and save the new BIOS file (e.g. N680SDQ6.F1) to your floppy disk or hard disk. Note: Q-Flash only supports hard disks or flash drives using FAT32/16/12 file system.
3. Restart the system. During BIOS POST, press the End key to enter Q-Flash. NOTE: Press the End key to enter Q-Flash if you wish to use hard drives in RAID/AHCI mode or hard drives attached to the independent IDE/SATA controller.

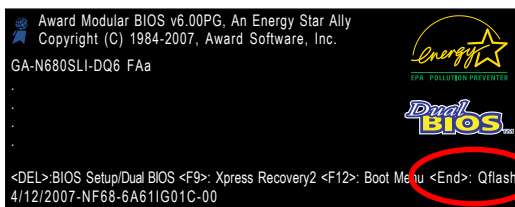

**<End>: Qflash**



CAUTION

Because BIOS flashing is potentially risky, please do it with caution and avoid inadequate operation that may result in system malfunction.

### Updating the BIOS

Step 1:

- a. In the Dual BIOS / Q-Flash menu, use the UP or DOWN ARROW key to select **Update Main BIOS from Drive** and press ENTER.



NOTE

If you wish to back up the current BIOS file, use the **Save Main BIOS to Drive** function.

- b. Select the floppy drive or hard drive where the BIOS file is saved, such as "Floppy A" and press ENTER.

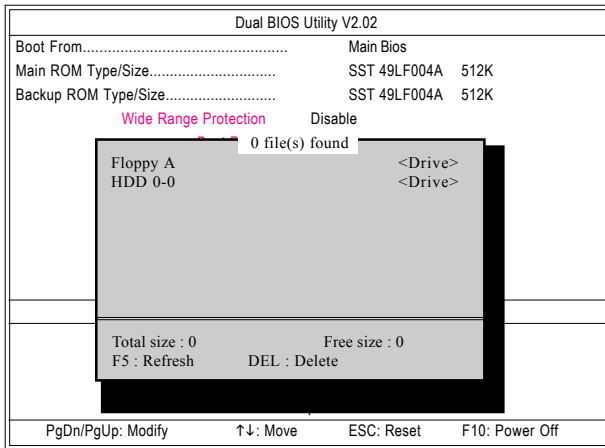

- c. Select the BIOS file and press ENTER.



Make sure again the BIOS file matches your motherboard model.

- Step 2: The process of system reading the BIOS file from the floppy disk is displayed on the screen. When the message "Are you sure to update BIOS?" appears, press ENTER. The BIOS update will begin and the current process will be displayed.



1. Do not turn off or restart the system when the system is reading/updating the BIOS.
2. Do not remove the floppy disk or hard drive/USB drive when the system is updating the BIOS.

- Step 3: When the update process is complete, press any key to return to the Dual BIOS / Q-Flash main menu.

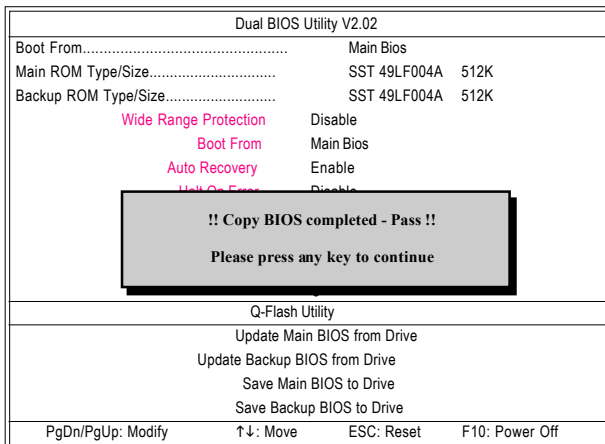

Step 4: Press ESC and then ENTER to exit Dual BIOS / Q-Flash and the system will restart. As the system reboots, you will see the new BIOS version during POST.

Step 5: As the system reboots, press DELETE to enter BIOS Setup. Select **Load Optimized Defaults** and press ENTER to load BIOS defaults. System will re-detect all peripheral devices after BIOS update, so we recommend that you reload BIOS defaults.

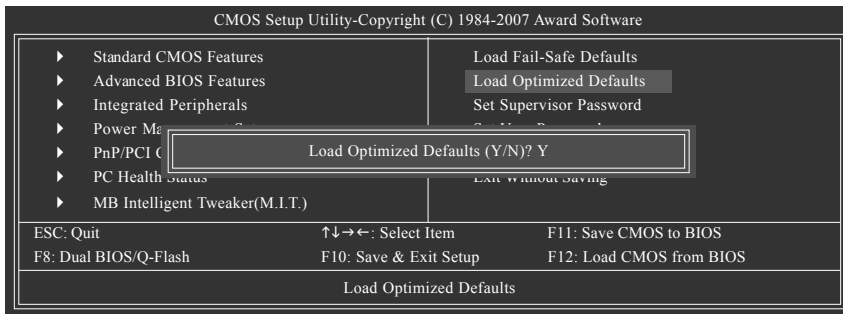

Press Y to load BIOS defaults

Step 6: Select **Save & Exit Setup** and then press **Y** to save settings to CMOS and exit BIOS Setup. When the system restarts, the whole update process is complete.





## Method 2 : @BIOS™ Utility

If you do not have a DOS startup disk, we recommend that you use the new @BIOS utility. @BIOS allows users to update their BIOS under Windows. Just select the desired @BIOS server to download the latest version of BIOS.

Fig 1. Installing the @BIOS utility

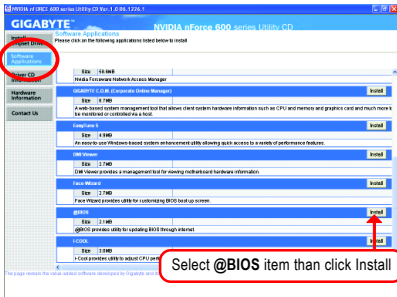

Fig 2. Installation Complete and Run @BIOS

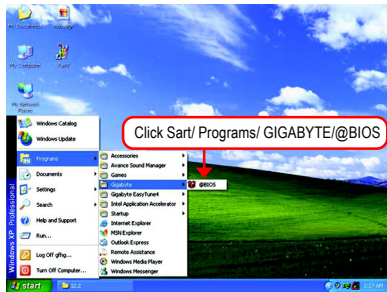

Fig 3. The @BIOS Utility

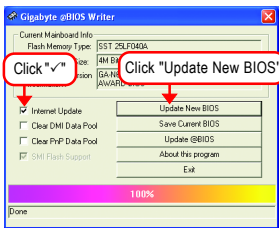
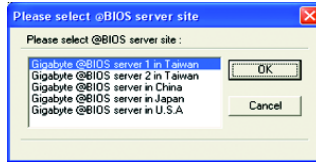

Fig 4. Select the desired @BIOS server



## 1. Methods and steps:

### I. Update BIOS through Internet

- Click "Internet Update" icon
- Click "Update New BIOS" icon
- Select @BIOS™ sever
- Select the exact model name on your motherboard
- System will automatically download and update the BIOS.

### II. Update BIOS NOT through Internet:

- Do not click "Internet Update" icon
- Click "Update New BIOS"
- Please select "All Files" in dialog box while opening the old file.
- Please search for BIOS unzip file, downloading from internet or any other methods (such as: N680SDQ6.F1).
- Complete update process following the instruction.

### III. Save BIOS

In the very beginning, there is "Save Current BIOS" icon shown in dialog box. It means to save the current BIOS version.

### IV. Check out supported motherboard and Flash ROM:

In the very beginning, there is "About this program" icon shown in dialog box. It can help you check out which kind of motherboard and which brand of Flash ROM are supported.

## 2. Note:

- I. In method I, if it shows two or more motherboard's model names to be selected, please make sure your motherboard's model name again. Selecting wrong model name will cause the system unbooted.
- II. In method II, be sure that motherboard's model name in BIOS unzip file are the same as your motherboard's. Otherwise, your system won't boot.
- III. In method I, if the BIOS file you need cannot be found in @BIOS™ server, please go onto Gigabyte's web site for downloading and updating it according to method II.
- IV. Please note that any interruption during updating will cause system unbooted.
- V. Do not use @BIOS and C.O.M. (Corporate Online Management) at the same time.

## 4-1-4 Configuring SATA Hard Drive(s)

To configure SATA hard drive(s), follow the steps below:

- (1) Install SATA hard drive(s) in your system.
- (2) Configure SATA controller mode and boot sequence in BIOS Setup.
- (3) Configure RAID set in RAID BIOS. <sup>(Note 1)</sup>
- (4) Make a floppy disk containing the SATA controller driver. <sup>(Note 1), (Note 2)</sup>
- (5) Install the SATA controller driver during OS installation. <sup>(Note 1), (Note 2)</sup>

### Before you begin

Please prepare:

- (a) At least two SATA hard drives (to ensure optimal performance, it is recommended that you use two hard drives with identical model and capacity). If you do not want to create RAID, you may prepare only one hard drive.
- (b) An empty formatted floppy disk.
- (c) Windows XP/2000 setup disk.
- (d) Driver CD for your motherboard.

## A. nVIDIA® nForce 680i SLI Southbridge

### (1) Installing SATA hard drive(s) in your computer

Attach one end of the SATA signal cable to the rear of the SATA hard drive and the other end to available SATA port(s) on the motherboard. If there are more than one SATA controller on your motherboard, refer to the connectors introduction section of the user's manual to identify the SATA controller for the connectors. (For example, on the GA-N680SLI-DQ6 motherboard, the SATAII0, SATAII1, SATAII2, SATAII3, SATAII4 and SATAII5 connectors are supported by the nVIDIA® nForce 680i SLI Southbridge.) Then connect the power connector from your power supply to the hard drive.

(Note 1) Required for setting up RAID array.

(Note 2) Required when the SATA controller is set to AHCI Mode(Only for GIGABYTE SATA2 Controller).

## (2) Configuring SATA controller mode and boot sequence in BIOS Setup

Make sure to configure the SATA controller mode correctly in system BIOS Setup and set the first boot device.

Step 1:

Turn on your computer and press Del to enter BIOS Setup during POST (Power-On Self Test). In the example in Figure 1, make sure that **NV Serial-ATA Controller** under the **Integrated Peripherals** menu is enabled. If you wish to create RAID array, press ENTER on the **Serial-ATA RAID Config** item to enter the submenu .

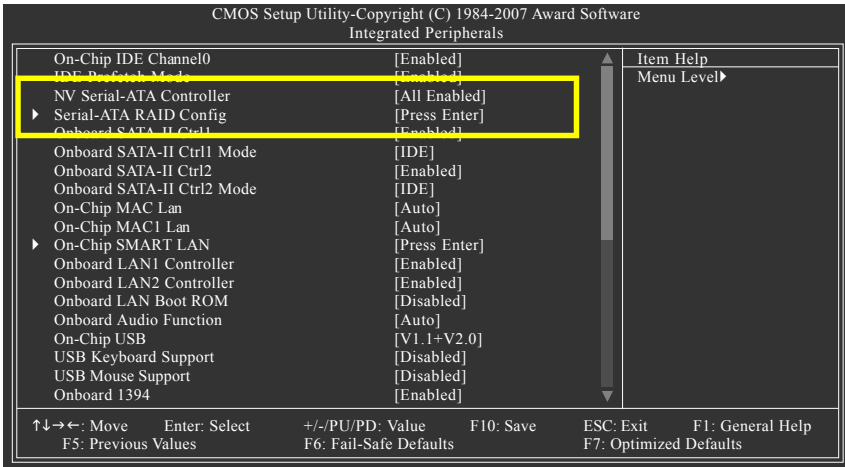

Figure 1

To set up a RAID array, ensure that **NV SATA RAID function** is enabled (Figure 2), otherwise leave it disabled. Then enable the SATA channels with hard disks that you want to use for RAID (for example, **NV SATA1 Primary RAID** controls the SATA110 connector and **NV SATA 1 Secondary RAID** controls the SATA111 connector) (Figure 2).

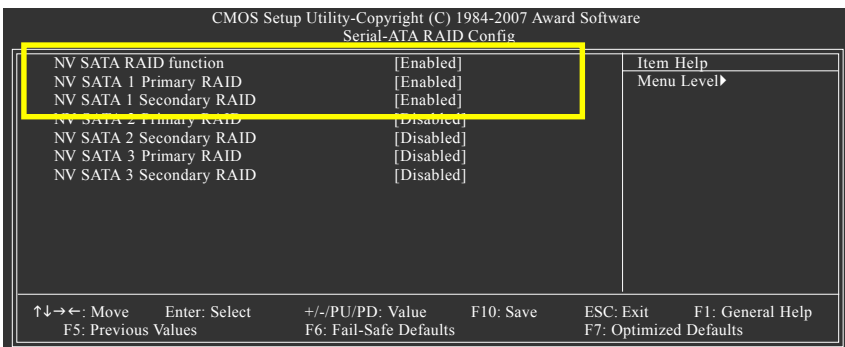

Figure 2



The BIOS Setup menus described in this section may not show the exact settings for your motherboard. The actual BIOS Setup menu options you will see shall depend on the motherboard you have and the BIOS version.

Step 2:

Set **First Boot Device** under the **Advanced BIOS Features** menu to **CDROM** to boot from CD-ROM after system restarts (Figure 3).

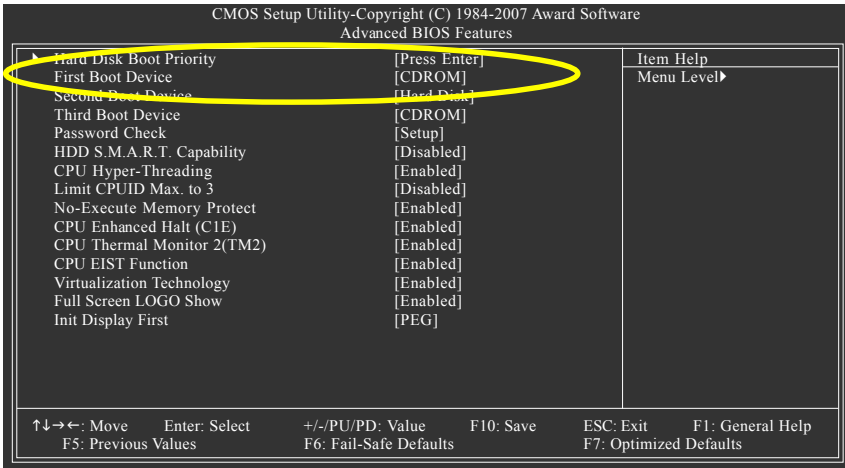

Figure 3

Step 3:

Save and exit BIOS Setup.

### (3) Configuring RAID set in RAID BIOS

Enter the RAID BIOS setup utility to configure a RAID array. Skip this step if you do not want to create RAID.

#### Step 1:

After the POST memory test begins and before the operating system boot begins, look for a message which says "Press F10 to enter RAID setup utility" (Figure 4). Hit the **F10** key to enter the RAID BIOS setup utility.

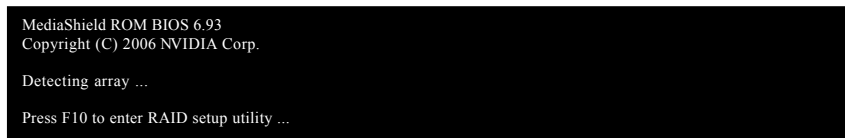

Figure 4

#### Step 2:

The Define a New Array screen is the first option screen when you enter the NVIDIA RAID setup utility. (Figure 5). You can press the TAB key to highlight through options.

#### Step 3:

In the RAID Mode field, use the UP or DOWN ARROW key to select a RAID mode. The supported RAID modes include Mirroring (default), Striping, Stripe Mirroring, Spanning and RAID 5. The following is an example of RAID 0 array creation.

#### Step 4:

If RAID 0 (Striping) is selected, you can manually set the striping block size. In the Striping Block field, use the UP or DOWN ARROW key to set the Striping Block size. The KB is the standard unit of Striping Block size. We recommend you leaving it to the default setting--Optimal (64K). The size range is from 4K to 128K.

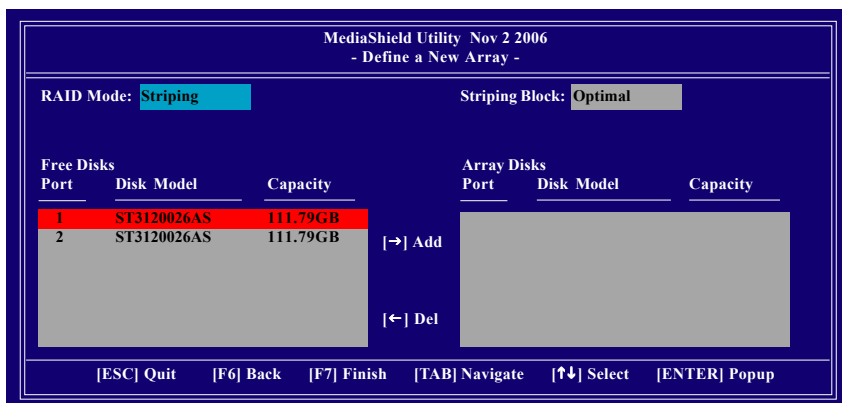

Figure 5

## Step 5:

Next, select the hard drives which you wish to be included in the disk array. The Free Disks section displays the information about the currently installed SATA hard drives. Press the TAB key to move to the Free Disks section. Select the target hard drives using the UP or DOWN ARROW key and use the RIGHT ARROW key to add the hard drives to the Array Disks section (Figure 6).

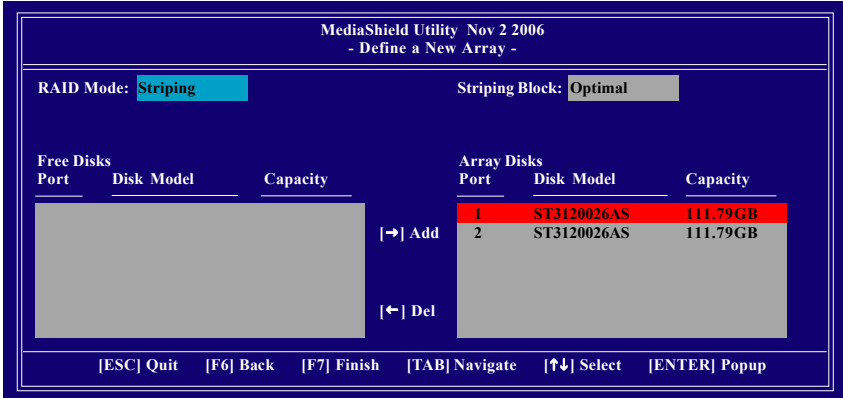

Figure 6

## Step 6:

Press F7 after selecting the target hard disks. A message which says "Clear disk data?" will appear (Figure 7). If you are sure to clear the data in the selected hard drives, press Y. (If the hard drives contain previously created RAID array, you need to press Y to clear the data from the hard drives.)

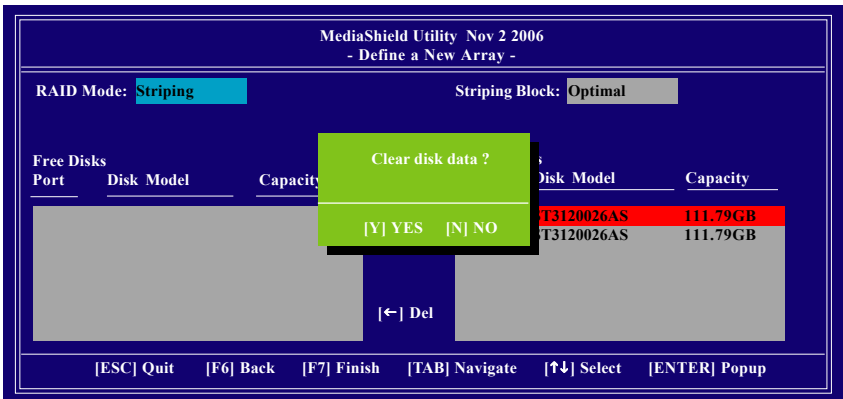

Figure 7

After that, the Array List screen displaying the RAID array you created will appear (Figure 8). (Note: **BBS** stands for BIOS Boot Specification. This indicates that the boot device is defined in the BIOS.)

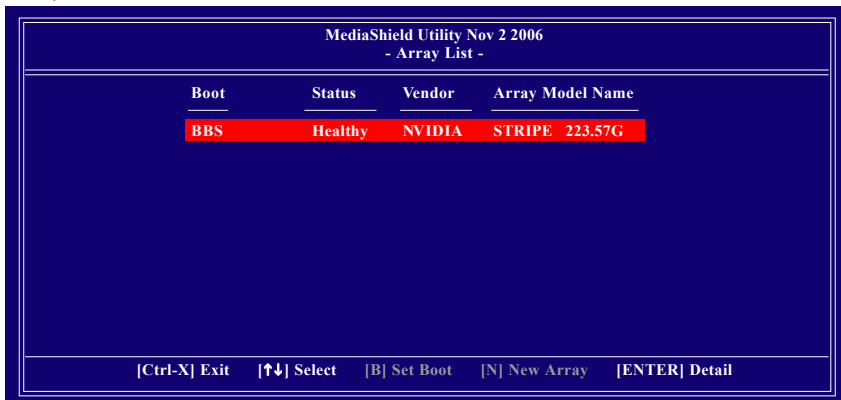

Figure 8

To read more information about the RAID array, press ENTER to enter the Array Detail screen (Figure 9), where you should see detailed information about RAID mode, disk block size, disk model name, and disk capacity, etc.

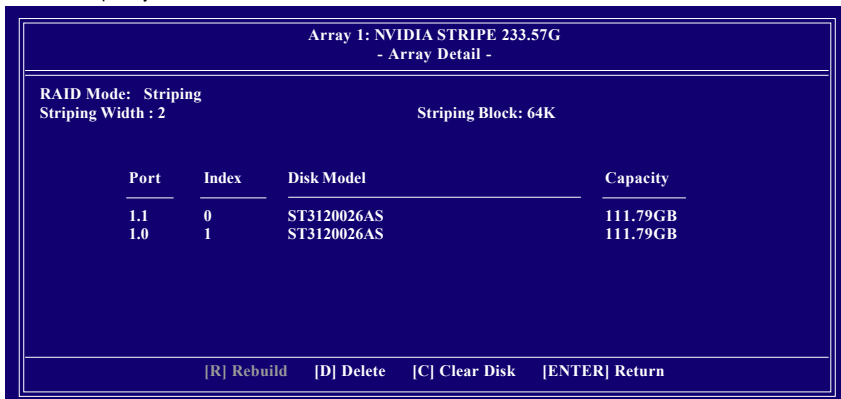

Figure 9

To delete the array, press D in the Array Detail screen. When the "Delete this array?" message appears, press Y to confirm or N to cancel. Press ENTER to return to the Array List screen.

To exit the Nvidia RAID utility, press ESC in the main menu or Ctrl+X in the Array List screen.

Now, you can proceed to install the SATA controller driver and operating system.



### (4) Making a SATA Driver Disk

To install operating system onto RAID disks successfully, you need to install the SATA RAID driver during OS installation. Without the driver, the hard disk may not be recognized during the Windows setup process. Skip this step if you do not want to create RAID. First of all, copy the driver for the SATA controller from the motherboard driver CD-ROM to a floppy disk. See the instructions below about how to copy the driver in MS-DOS mode<sup>(Note)</sup>. Prepare a startup disk that has CD-ROM support and a blank formatted floppy disk.

Step 1: Insert the prepared startup disk and motherboard driver CD-ROM in your system. Boot from the startup disk. Once at the A:\> prompt, change to the CD-ROM drive (example: D:\>). At the D:\> prompt, type the following two commands. Press ENTER after each command (Figure 10):

```
cd bootdrv
menu
```

Step 2: When the controller menu (Figure 11) appears, remove the startup disk and insert the blank formatted disk. Select the controller driver by pressing the corresponding letter from the menu. For example, from the menu in Figure 11, press G to select (G) NVIDIA nFORCE 600 Series Raid (XP) if you wish to install Windows XP (32-bit). Your system will then automatically zip and transfer this driver file to the floppy disk. Press 0 to exit when finished.

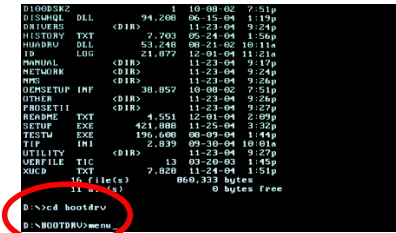

Figure 10

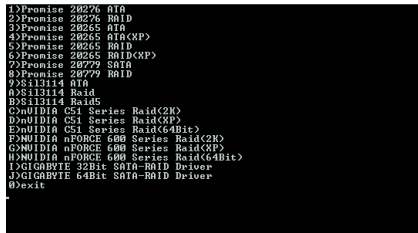

Figure 11

(Note) For users without a startup disk:

Use an alternative system and insert the GIGABYTE motherboard driver CD-ROM. From the CD-ROM drive folder, double click the MENU.exe file in the BootDrv folder (Figure 12). A command prompt window will open similar to that in Figure 11.

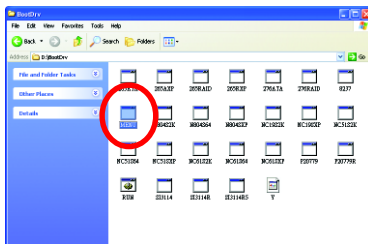

Figure 12

## (5) Installing SATA controller driver during OS installation

Now that you have prepared the SATA driver disk and configured BIOS settings, you are ready to install Windows 2000/XP onto your SATA hard drive with the SATA driver. The following is an example of Windows XP installation.

Step 1: Restart your system to boot from the Windows 2000/XP Setup disk and press F6 as soon as you see the "Press F6 if you need to install a 3rd party SCSI or RAID driver" message (Figure 13). After pressing F6, there will be a few moments of some files being loaded before you see the next screen.

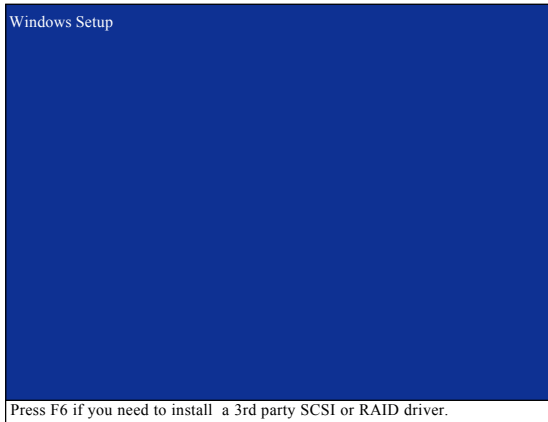

Figure 13

Step 2:

When a screen similar to that below appears, insert the floppy disk containing the SATA driver and press S (Figure 14).

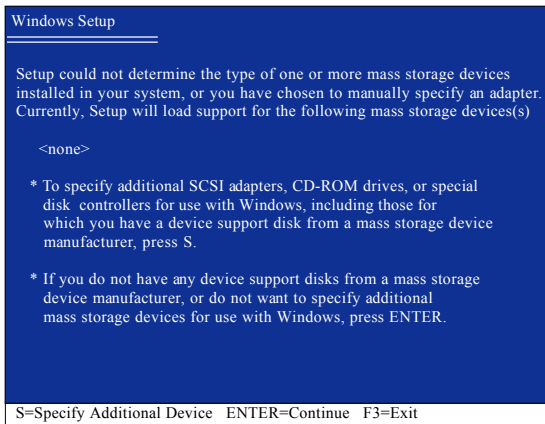

Figure 14

**Step 3:**

If Setup correctly recognizes the driver in the floppy disk, a controller menu similar to Figure 15 below will appear. Use the ARROW keys to select **NVIDIA RAID CLASS DRIVER** (Figure 15) and press ENTER. Later, when a screen similar to Figure 16 appears, you must press S to select additional driver. The screen will return to previous screen as shown in Figure 15. Select **NVIDIA nForce Storage Controller** and press ENTER.

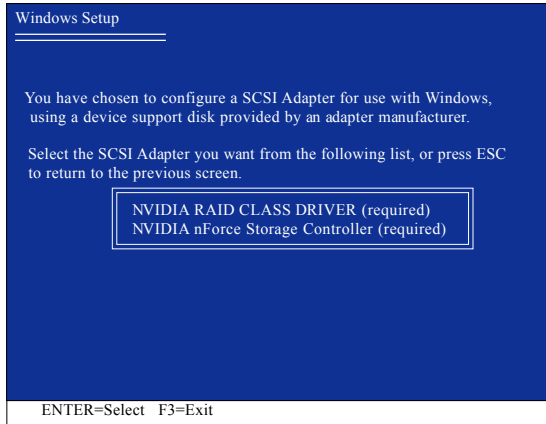

Figure 15

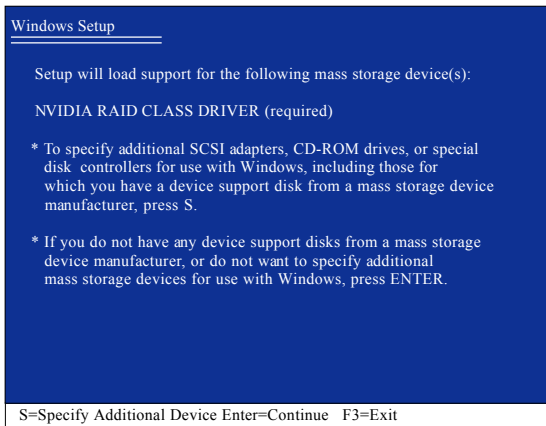

Figure 16



If a message appears saying one or some file(s) cannot be found, please check the floppy disk or copy the correct SATA driver again from the motherboard driver CD.

## Step 4:

When the next screen (Figure 17) appears, press ENTER to continue the SATA driver installation from the floppy disk.

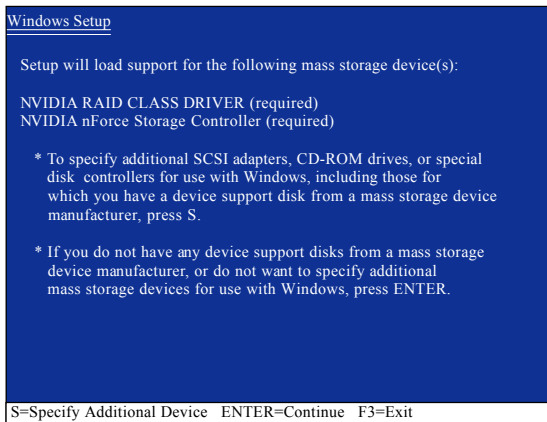

Figure 17

After the SATA controller driver installation is completed, you can proceed with the Windows 2000/XP installation.

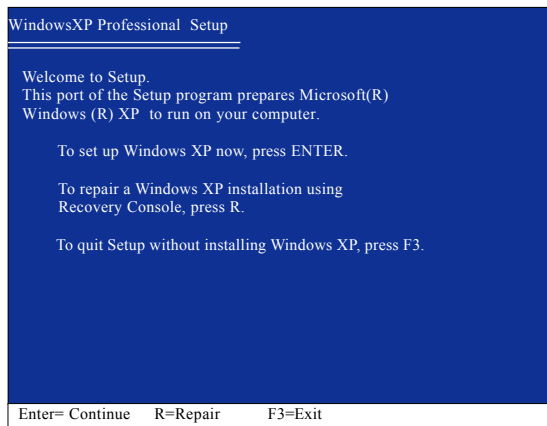

Figure 18

(Note: Each time you add a new hard drive to a RAID array, the RAID driver will have to be installed under Windows once for that hard drive. After that, the driver will not have to be installed.)

## B. GIGABYTE SATA2 Controller

### (1) Installing SATA hard drive(s) in your computer

Attach one end of the SATA signal cable to the rear of the SATA hard drive and the other end to available SATA port(s) on the motherboard. If there are more than one SATA controller on your motherboard, refer to the connectors introduction section of the user's manual to identify the SATA controller for the connectors. (For example, on the GA-N680SLI-DQ6 motherboard, the GSATAII0, GSATAII1, GSATAII2 and GSATAII3 connectors are supported by the GIGABYTE SATA2 controller.) Then connect the power connector from your power supply to the hard drive.

### (2) Configuring SATA controller mode and boot sequence in BIOS Setup

Make sure to configure the SATA controller mode correctly in system BIOS Setup and set the first boot device.

#### Step 1:

Turn on your computer and press Del to enter BIOS Setup during POST (Power-On Self Test). In BIOS Setup, go to **Integrated Peripherals**, ensure that the **Onboard SATA-II Ctrl1** or **Onboard SATA-II Ctrl2** is enabled. Then set **Onboard SATA-II Ctrl1 Mode** or **Onboard SATA-II Ctrl2 Mode** to **RAID** before configuring RAID. If you do not want to create RAID, set this item to **IDE** or **AHCI**, depending on your need (Figure 1).

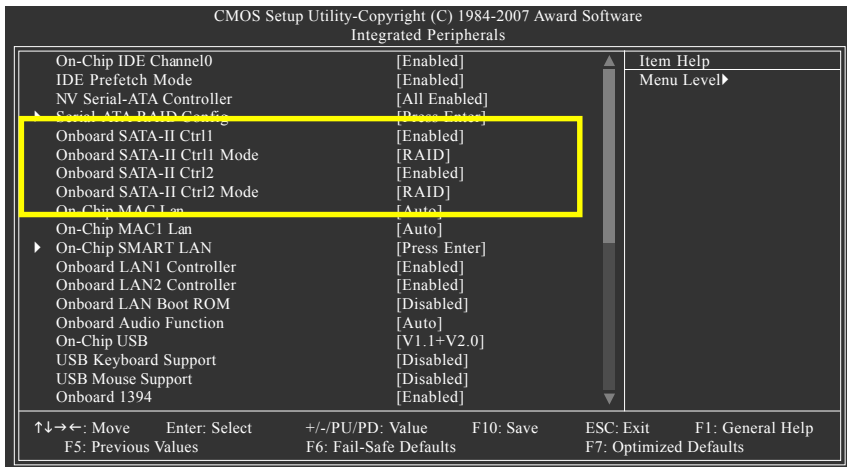

Figure 1



The BIOS Setup menus described in this section may not show the exact settings for your motherboard. The actual BIOS Setup menu options you will see shall depend on the motherboard you have and the BIOS version.

Step 2:

To boot from Windows installation CD-ROM disk, set **First Boot Device** under the **Advanced BIOS Features** menu to **CDROM** (Figure 2).

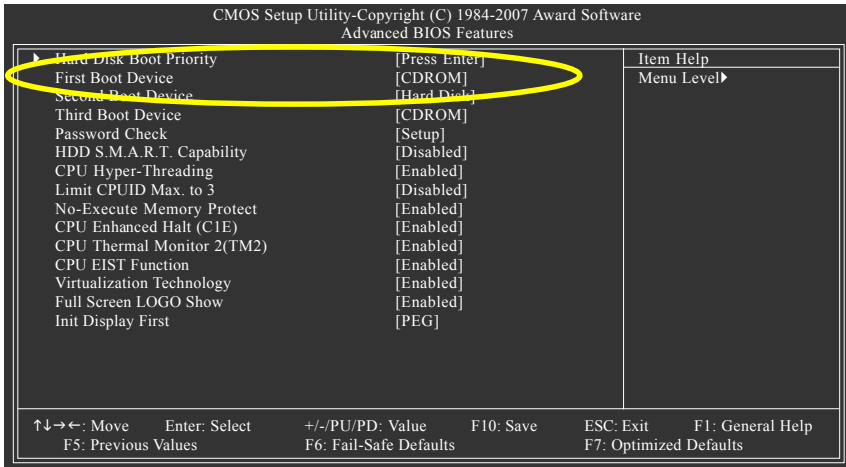

Figure 2

Step 3:

Save and exit BIOS Setup.

### (3) Configuring RAID array in RAID BIOS

Enter the RAID BIOS setup utility to configure a RAID array. Skip this step if you do not want to create RAID.

Step 1:

After the POST memory test begins and before the operating system boot begins, look for a message which says "Press <Ctrl-G> to enter RAID Setup Utility" (Figure 3). Press CTRL+ G to enter the GIGABYTE SATA2 RAID BIOS setup utility.



Figure 3

In the main screen of the GIGABYTE SATA2 RAID BIOS utility (Figure 4), use the UP or DOWN ARROW key to highlight through choices. Highlight the item that you wish to execute and press ENTER.

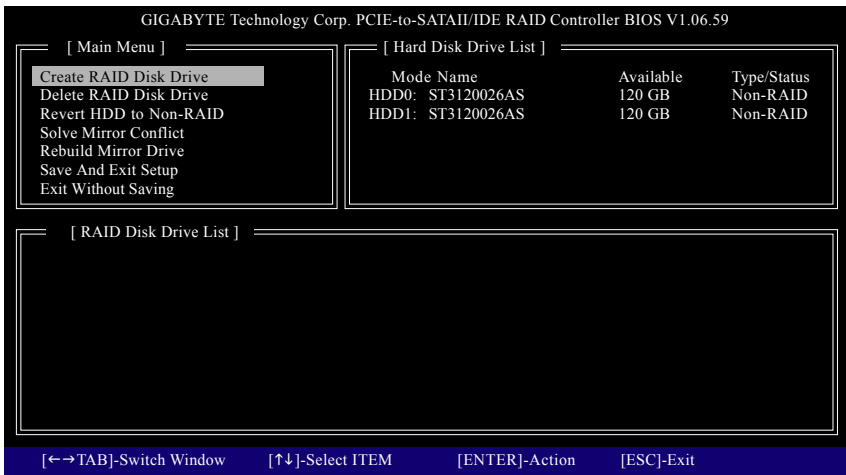

Figure 4

**Note:** In the main screen, you can select a hard disk in the **Hard Disk Drive List** block and press ENTER. This allows you to check detailed information about the selected hard disk.

## A. Create Array:

In the main screen, press ENTER on the **Create RAID Disk Drive** item. Then the RAID creation screen appears (Figure 5).

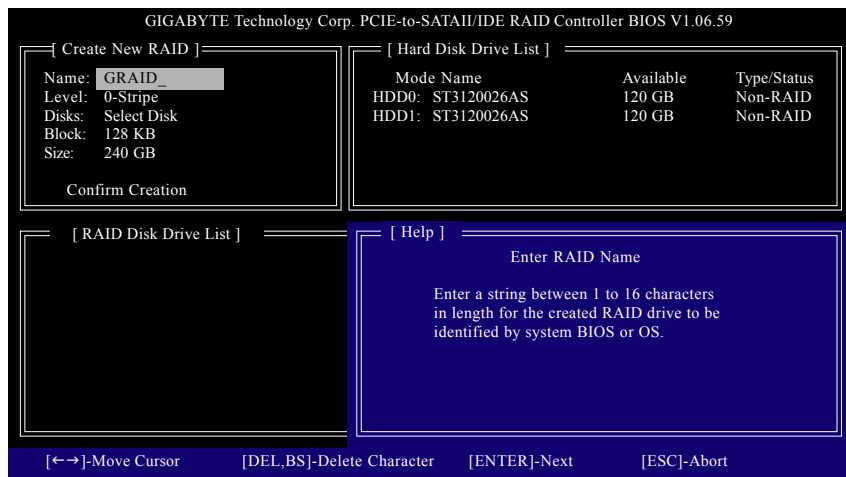

Figure 5

In the RAID creation screen, the **Create New RAID** block displays all the items that need to be set for creating an array (Figure 5). The following procedure uses RAID 0 creation as an example.

### Steps:

- 1. Enter Array Name:** Under the **Name** item, enter an array name with 1~16 letters (letters cannot be special characters) and press ENTER.
- 2. Select RAID Mode:** Under the **Level** item, use UP or DOWN ARROW key to select RAID 0 (Stripe), RAID 1 (Mirror), or JBOD (Figure 6). Then press ENTER to move onto the next step.

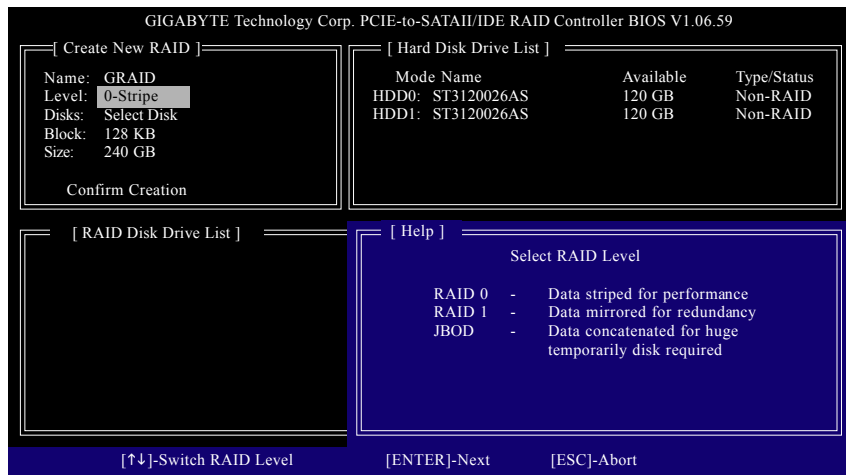

Figure 6



- 3. Assign Array Disks:** After RAID mode is selected, RAID BIOS automatically assigns the two hard disks installed as the RAID disks.
- 4. Set Block Size (only for RAID 0):** Under the **Block** item, use the UP or DOWN ARROW key to select the block size (Figure 7), ranging from 4K to 128K. Press ENTER when finished.

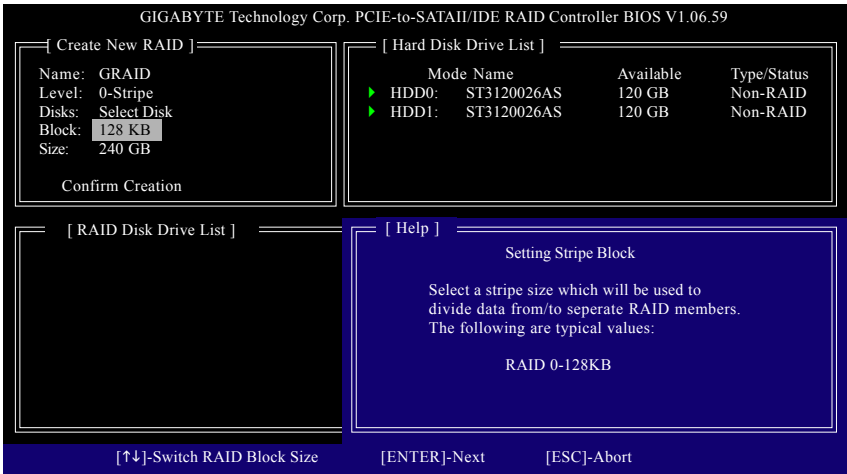

Figure 7

- 5. Set Array Size:** Under the **Size** item, type the size of the array (Figure 8), and press ENTER.

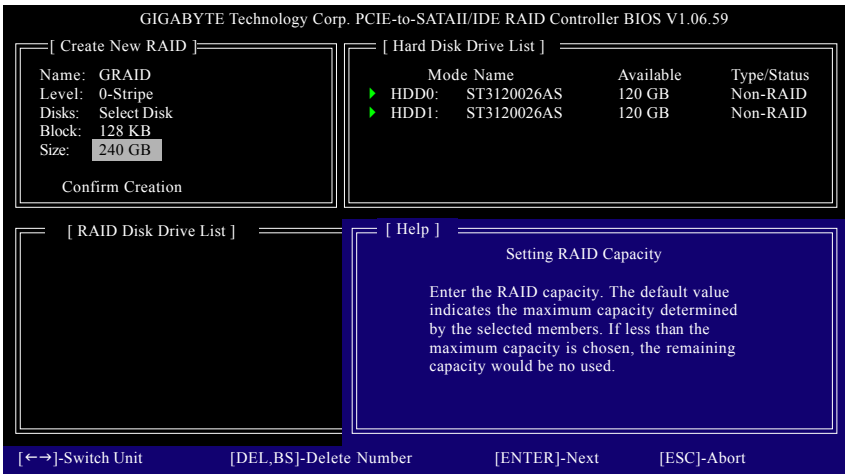

Figure 8

6. **Confirm Creation:** After all of the items are configured, the selection bar automatically jumps to the **Confirm Creation** item. When prompted to confirm your selections (Figure 9), press Y to confirm or N to abort.

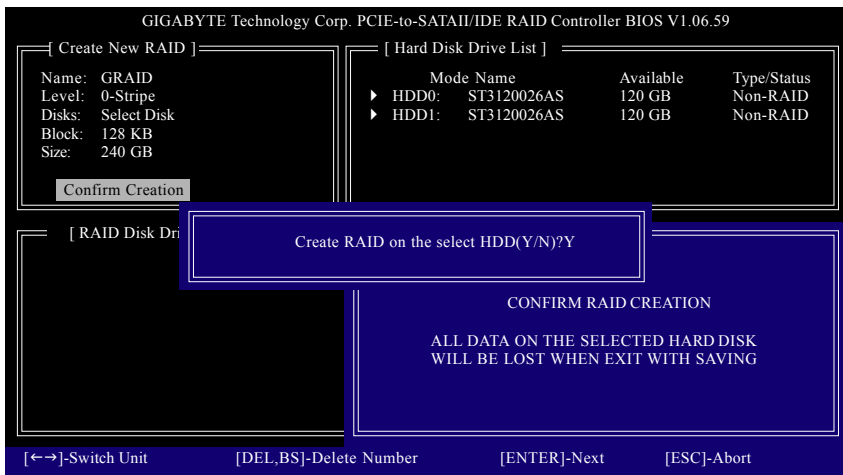

Figure 9

When finished, the new RAID array will be displayed in the **RAID Disk Drive List** block (Figure 10).

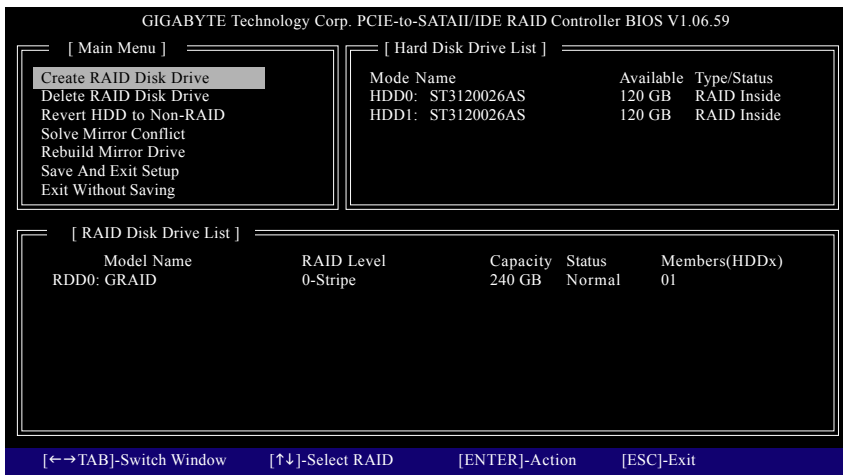

Figure 10

To check more detailed information about the array, use the TAB key while in the **Main Menu** block to move the selection bar to the **RAID Disk Drive List** block. Select the array and press ENTER. A small window displaying the array information will appear in the center of the screen (Figure 11).

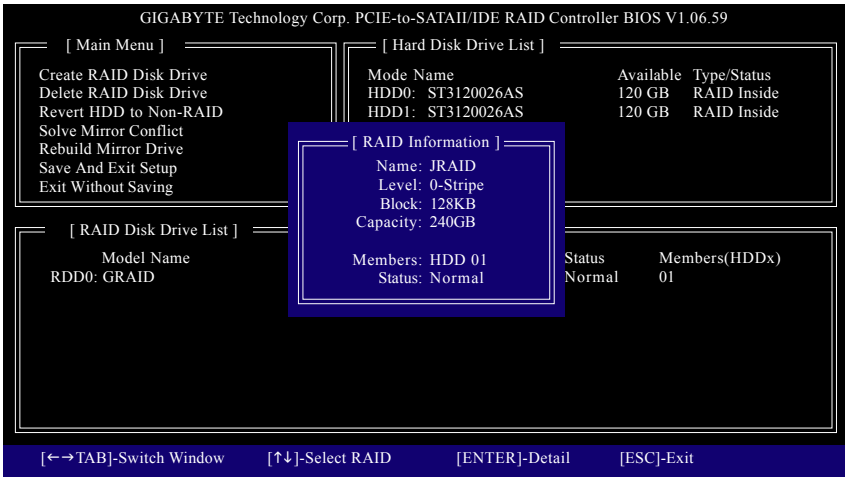

Figure 11

After configuring the RAID array, select the **Save And Exit Setup** item in the main screen to save your settings if you wish to exit the RAID BIOS utility, then press Y (Figure 12).

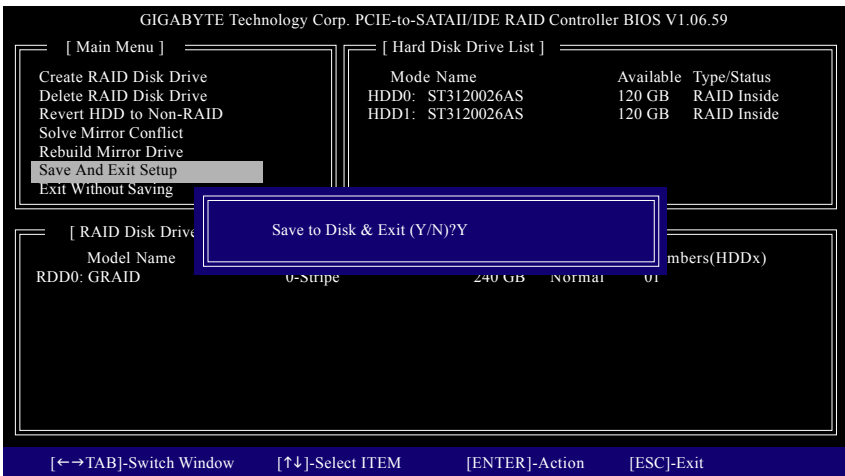

Figure 12

## B. Delete Array:

To delete the array, select **Delete RAID Disk Drive** in the main menu and press ENTER. The selection bar will move to the **RAID Disk Drive List** block. Press the SPACEBAR on the array to be deleted; a small triangle will appear to mark the selected array (Figure 13). Press Del.

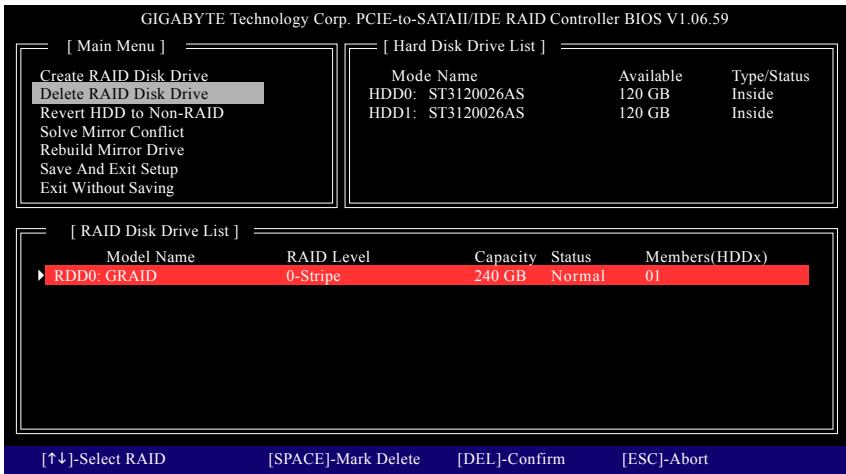

Figure 13

Press Y to confirm yes to the following message (Figure 14) or N to cancel.

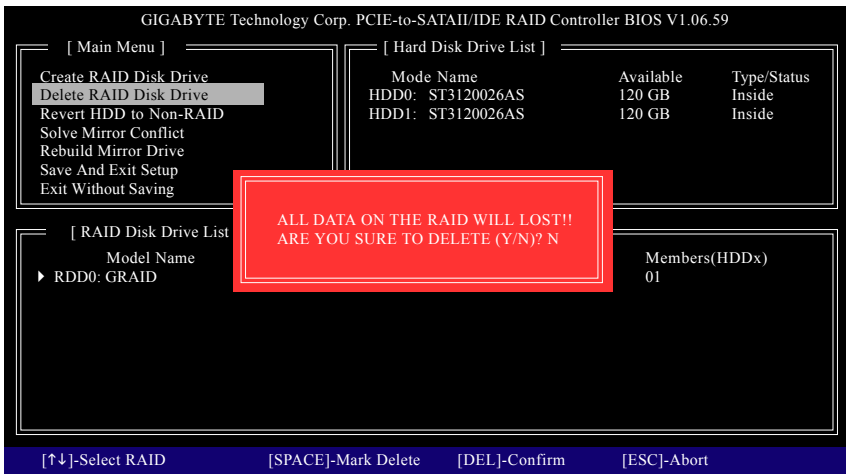

Figure 14

Now, you can proceed to install the SATA controller driver and operating system.

#### (4) Making a SATA Driver Disk (Required for AHCI and RAID Mode)

To install operating system onto a serial ATA hard disk successfully, you need to install the SATA controller driver during OS installation. Without the driver, the hard disk may not be recognized during the Windows setup process. First of all, copy the driver for the SATA controller from the motherboard driver CD-ROM to a floppy disk. See the instructions below about how to copy the driver in MS-DOS mode<sup>(Note 1)</sup>. Prepare a startup disk that has CD-ROM support and a blank formatted floppy disk.

Step 1: Insert the prepared startup disk and motherboard driver CD-ROM in your system. Boot from the startup disk. Once at the A:\> prompt, change to the CD-ROM drive (example: D:\>). At the D:\> prompt, type the following two commands. Press ENTER after each command (Figure 15):

```
cd bootdrv
menu
```

Step 2: When the controller menu (Figure 16) appears, remove the startup disk and insert the blank formatted disk. Select the controller driver by pressing the corresponding letter from the menu. For example, from the menu in Figure 16, press I to select I) GIGABYTE 32Bit SATA-RAID Driver for Windows operating system<sup>(Note 2)</sup>. Your system will then automatically zip and transfer this driver file to the floppy disk. Press 0 to exit when finished.

```
D:\BOOTDRV 1 10:00:02 7:51p
DISMOL DLL 94,266 06-15-04 1:39p
DRIVERS <DIR> 11-23-04 9:24p
HISTORY TXT 7,703 05-24-04 1:56p
HIDHDD DLL 53,248 08-21-02 10:11a
IO <DIR> 12-01-04 11:21a
MFMHDL <DIR> 11-23-04 9:24p
NETWORK <DIR> 11-23-04 9:24p
MS <DIR> 11-23-04 9:24p
DEPSETUP INF 38,857 10-08-02 7:51p
OTHER <DIR> 11-23-04 9:24p
PROSET11 <DIR> 11-23-04 9:27p
RDOWNE TXT 4,551 12-01-04 2:09p
SETUP EXE 421,888 11-25-04 9:32p
TESTM EXE 196,080 08-09-04 1:44p
TIP INF 2,835 09-30-04 10:01a
UTILITY <DIR> 11-23-04 9:27p
VERFILE TIC 13 03-28-02 1:49p
XUCB TXT 7,828 11-24-04 1:51p
16 Files(s) 860,333 bytes
11 Dir(s) 0 bytes free

D:\>cd bootdrv
D:\BOOTDRV>menu
```

Figure 15

```
1)Promise 28276 RAID
2)Promise 28276 RAID
3)Promise 28265 ATA
4)Promise 28265 RAID(XP)
5)Promise 28265 RAID
6)Promise 28265 RAID(XP)
7)Promise 28779 SATA
8)Promise 28779 RAID
9)S13114 ATA
AS13114 RAID
BS13114 RAID
CandIDE CS1 Series Raid(2K)
DnUIDIA CS1 Series Raid(XP)
EduUIDIA CS1 Series Raid(64Bit)
FNUUIDIA nFORCE 680 Series Raid(2K)
GnuUIDIA nFORCE 680 Series Raid(XP)
HNUUIDIA nFORCE 680 Series Raid(64Bit)
I)GIGABYTE 32bit SATA-RAID Driver
J)GIGABYTE 64bit SATA-RAID Driver
0)exit
```

Figure 16

(Note 1) For users without a startup disk:

Use an alternative system and insert the GIGABYTE motherboard driver CD-ROM. From the CD-ROM drive folder, double click the **MENU.exe** file in the **BootDrv** folder (Figure 17). A command prompt window will open similar to that in Figure 16.

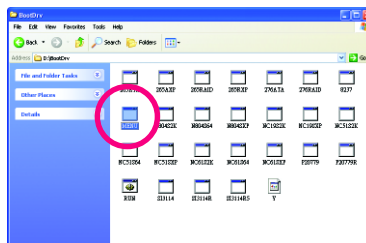

Figure 17

(Note 2) For 64-bit Windows Operating System, please select **GIGABYTE 64Bit SATA-RAID Driver**.

## (5) Installing SATA controller driver during OS installation

### (Required for AHCI and RAID Mode)

Now that you have prepared the SATA driver disk and configured BIOS settings, you are ready to install Windows 2000/XP onto your SATA hard drive with the SATA driver. The following is an example of Windows XP installation.

Step 1: Restart your system to boot from the Windows 2000/XP Setup disk and press F6 as soon as you see the "Press F6 if you need to install a 3rd party SCSI or RAID driver" message (Figure 18). After pressing F6, there will be a few moments of some files being loaded before you see the next screen.

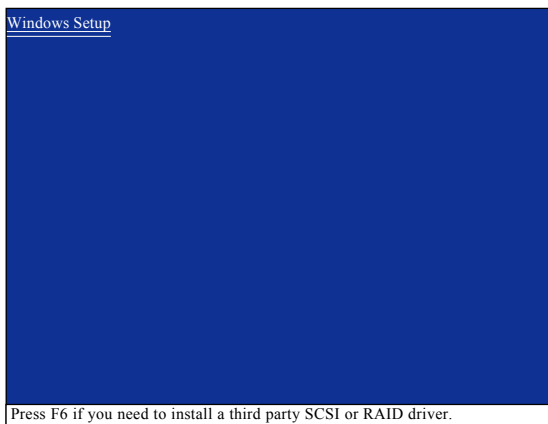

Figure 18

Step 2:

When a screen similar to that below appears, insert the floppy disk containing the SATA driver and press S (Figure 19).

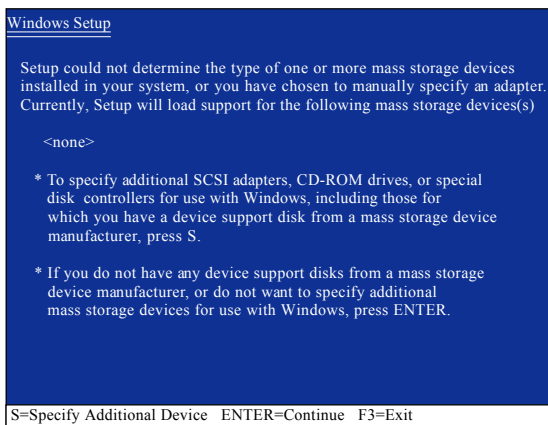

Figure 19

**Step 3:**

When Setup correctly recognizes the driver in the floppy disk, a controller menu similar to Figure 20 below will appear. Use the ARROW keys to select one of the items displayed depending on the operating system to be installed. For example, select **GIGABYTE GBB363 RAID Controller (Windows 2K/XP/2003)** <sup>(Note)</sup> if you wish to install Windows XP (32-Bit). Then press ENTER.

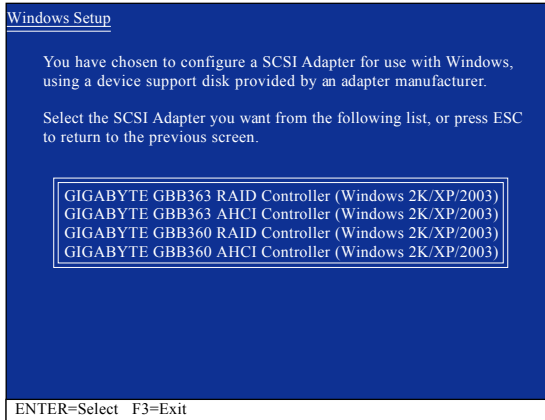

Figure 20



If a message appears saying one or some file(s) cannot be found, please check the floppy disk or copy the correct SATA driver again from the motherboard driver CD.

**Step 4:**

When the next screen (Figure 21) appears, press ENTER to continue the SATA driver installation from the floppy disk.

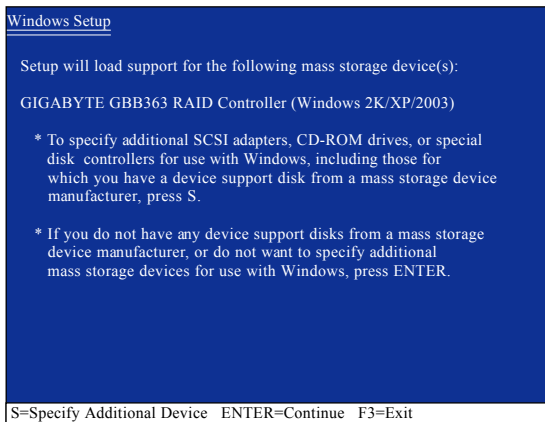

Figure 21

(Note) If you set the **Onboard SATA-II Ctrl1 Mode** or **Onboard SATA-II Ctrl2 Mode** item in BIOS Setup to AHCI mode, please select **GIGABYTE GBB363 AHCI Controller (Windows 2K/XP/ 2003)**.

**Step 5:**

After the SATA controller driver installation is completed, you can proceed with the Windows XP installation.

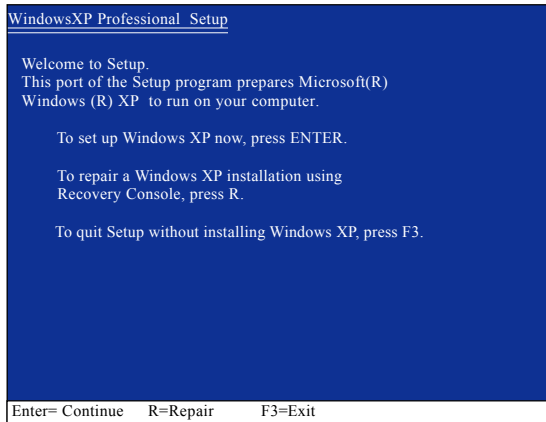

Figure 22





## 4-1-5 2- / 4- / 6- / 8- Channel Audio Function Introduction

The default speaker settings for the 6 audio jacks are as shown in the picture to the right. The jack retasking capability supported by HD Audio allows users to change the function for each audio jack by the audio software provided. For example, if a rear speaker is plugged into the center/subwoofer speaker out jack, you can change the center/subwoofer speaker out jack to function as a rear speaker out jack via the audio software. Please follow the steps to install the function. (Following pictures are in Windows XP)



Note that if you wish to connect a microphone, you MUST connect it to the default Mic In jack for the microphone to work correctly.

### HD Audio

With multiple built-in high quality digital-to-analog converters (DACs) that support audio output at up to 192 kHz/24-bit quality and multi-streaming applications, HD Audio is able to handle multiple audio streams (in and out) simultaneously. Multi-channel audio experiences have become a reality so you can, for instance, listen to MP3 music, have an Internet chat, make a telephone call over the Internet, and etc. all at the same time.

### Stereo Speakers Connection and Settings:

We recommend that you use the speaker with amplifier to acquire the best sound effect if the stereo output is applied.

#### STEP 1 :

After installation of the audio driver, you should find an Audio Manager  icon in your system tray (you can also find the icon in Control Panel). Double-click the icon to open the Audio Control Panel.

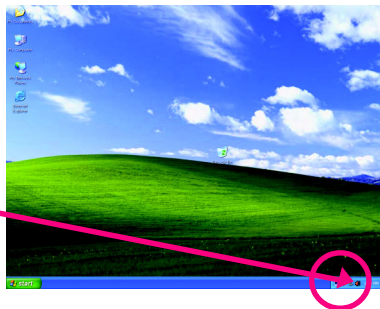

**STEP 2:**

In the Audio Control Panel, click the **Audio I/O** tab.  
In the upper left list, click **2CH Speaker**.

**STEP 3:**

After a speaker or headphone is plugged into the rear Line Out jack, a small window will pop up and ask you what type of equipment is connected. Choose **Headphone** or **Line Out** depending on the device connected and click **OK**. The 2-channel audio setup is completed.

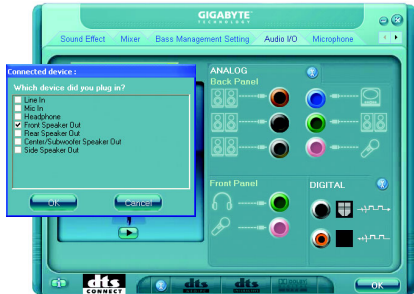
**4 Channel Audio Setup****STEP 1 :**

After installation of the audio driver, you should find an Audio Manager icon in your system tray (you can also find the icon in Control Panel). Double-click the icon to open the Audio Control Panel.

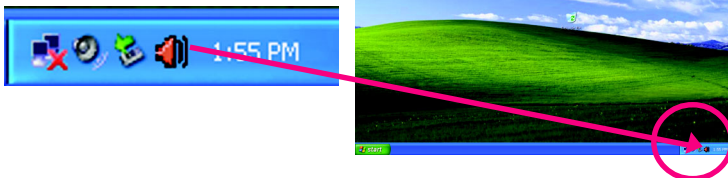
**STEP 2:**

In the Audio Control Panel, click the **Audio I/O** tab.  
In the upper left list, click **4CH Speaker**.



**STEP 3:**

After plugging in 4-channel speakers to the rear speaker jacks, a small window will pop up and ask you what type of equipment is connected. Choose a device depending on the type of speaker connected (4-channel audio consists of Front Speaker Out (Line Out) and Rear Speaker Out) and then click **OK**. The 4-channel audio setup is completed.

**6 Channel Audio Setup****STEP 1 :**

After installation of the audio driver, you should find an Audio Manager icon in your system tray (you can also find the icon in Control Panel). Double-click the icon to open the Audio Control Panel.

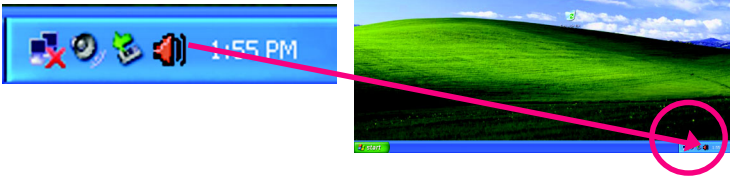
**STEP 2:**

In the Audio Control Panel, click the **Audio I/O** tab. In the upper left list, click **6CH Speaker**.

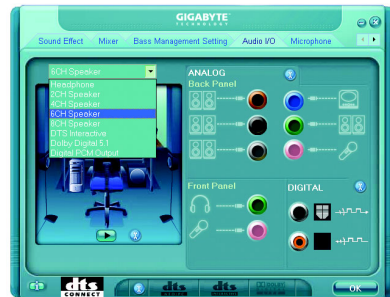
**STEP 3:**

After plugging in 6-channel speakers to the rear speaker jacks, a small window will pop up and ask you what type of equipment is connected. Choose a device depending on the type of speaker connected (6-channel audio consists of Front Speaker Out (Line Out), Rear Speaker Out, and Center/Subwoofer Speaker Out) then click **OK**. The 6-channel audio setup is completed.



## 8 Channel Audio Setup

### STEP 1 :

After installation of the audio driver, you should find an Audio Manager  icon in your system tray (you can also find the icon in Control Panel). Double-click the icon to open the Audio Control Panel.

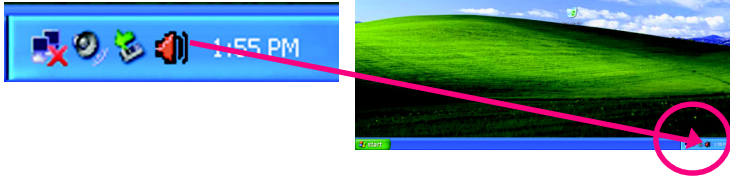

### STEP 2:

In the Audio Control Panel, click the **Audio I/O** tab. In the upper left list, click **8CH Speaker**.



### STEP 3:

After plugging in 8-channel speakers to the rear speaker jacks, a small window will pop up and ask you what type of equipment is connected. Choose a device depending on the type of speaker connected (8-channel audio consists of Front Speaker Out (Line Out), Rear Speaker Out, Center/Subwoofer Speaker Out, and Side Speaker Out) then click **OK**. The 8-channel audio setup is completed.

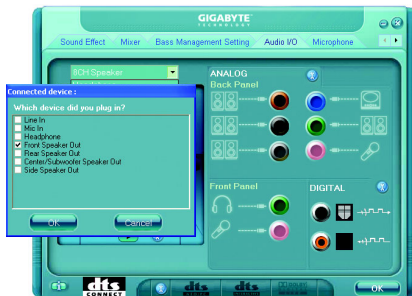

### Sound Effect Configuration:

At the **Sound Effect** menu, users can adjust sound option settings as desired.



### AC'97 Audio Configuration:

To enable the front panel audio connector to support AC97 Audio mode, go to the Audio Control Panel and click the **Audio I/O** tab. In the **ANALOG** area, click the **Tool** icon and then select the **Disable front panel jack detection** check box. This action completes the AC'97 Audio configuration.

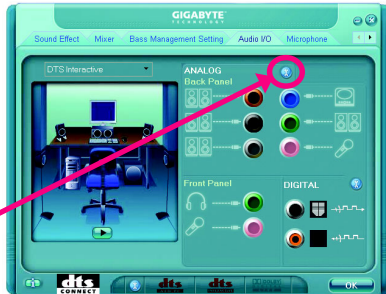



## Enabling the DTS (Digital Theater Systems) function

Before DTS is enabled, you would get only 2-channel output signals (from the front speakers) when playing 2-channel music. You must play 4-, 6-, or 8-channel music sources to produce 4-, 6-, or 8-channel audio effects.

With DTS enabled, the system will transform two-channel stereo source material into multi-channel audio output, creating a virtual surround sound environment<sup>(Note)</sup>.



After installing the audio driver, at the center bottom of the Audio Control Panel, you should find the DTS control button as shown below:



DTS control button

1. : This button provides you more controls over "dts NEO : PC".

Music Mode ; Cinema Mode

2. "dts NEO : PC" :

Press this button to enable or disable the dts NEO : PC function.

Enabling dts NEO : PC allows the system to transform ordinary 2-channel stereo content into 4-, 6-, or 8-channel surround sound, depending on your speaker configurations.

3. "dts INTERACTIVE" :

If your surround sound system is connected via an external decoder, click the Audio I/O tab in the Audio Control Panel. Either click DTS Interactive in the upper left list or click the dts INTERACTIVE button at the center bottom of the Audio Control Panel. And click the dts NEO : PC button.

The system will then simulate 5.1 channel surround sound playback from two-channel content.



(Note) When DTS Interactive is enabled, only digital audio output (S/PDIF) is working, and you will not hear sound from analog speaker or headphone.

## Introduction of Dolby Digital Live:



A real-time encoding technology, Dolby Digital Live converts any audio signal into a Dolby Digital bitstream for transport and playback through a home theater system. With it, your PC or game console can be hooked up to your Dolby Digital-equipped audio/video receiver or digital speaker system via a single digital connection, eliminating the confusion of multiple cables and ensuring the integrity of the audio signal.

In the Audio Control Panel, click the **Audio I/O** tab. Either click **Dolby Digital 5.1** in the upper left list or click the **Dolby Digital Live** button at the center bottom of the Audio Control Panel<sup>(Note)</sup>.

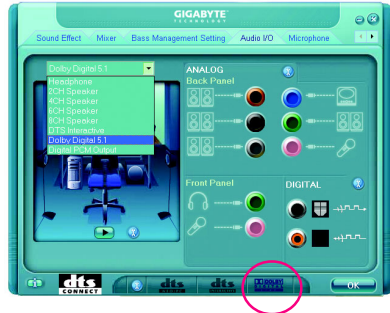

## Digital PCM Output Setup:

In the Audio Control Panel, click the **Audio I/O** tab. In the upper left list, click **Digital PCM Output**. Enable this function to allow digital audio sources that are not digitally processed by Dolby or DTS encoding to be output from the S/PDIF OUT.

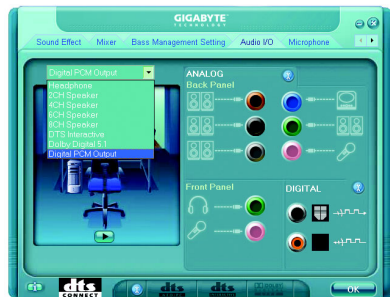

(Note) When Dolby Digital Live is enabled, only digital audio output (S/PDIF) is working, and you will not hear sound from analog speaker or headphone.



## 4-1-6 Windows Vista ReadyBoost

Windows ReadyBoost allows you to use flash memory on a Windows Vista certified USB flash drive to boost your computer's performance. You may enable ReadyBoost and allocate part of your USB flash drive's memory to speed up your computer.

Follow the steps below to enable the ReadyBoost function:

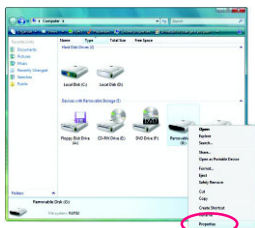

Step 1:

Go to **Computer**. Right-click on the USB flash drive icon and choose **Properties**.

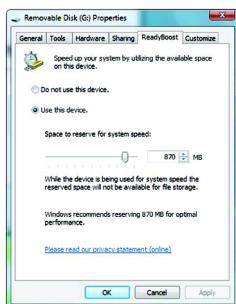

Step 2:

In the **ReadyBoost** tab, select **Use this device**. Under **Space to reserve for system speed**, set the amount of memory space to use for ReadyBoost using the slider or spin box. Click **Apply** and then **OK** to turn on ReadyBoost.



- The USB flash drive must have at least 256 MB of space.
- The recommended amount of memory to use for ReadyBoost acceleration is one to three times the amount of RAM installed in your computer.



## 4-2 Troubleshooting

Below is a collection of general asked questions. To check general asked questions based on a specific motherboard model, please log on to GIGABYTE's website.

Question 1: I cannot see some options that were included in previous BIOS after updating BIOS. Why?

Answer: Some advanced options are hidden in new BIOS version. Please press Ctrl and F1 keys after entering BIOS menu and you will be able to see these options.

Questions 2: Why is the light of my keyboard/optical mouse still on after computer shuts down?

Answer: In some boards, a small amount of electricity is kept on standby after computer shuts down and that's why the light is still on.

Question 3: How do I clear CMOS?

Answer: If your board has a Clear CMOS jumper, please refer to the Clear CMOS steps in the manual. If your board doesn't have such jumper, you can take off the on-board battery to leak voltage to clear CMOS. Please refer to the steps below:

Steps:

1. Turn off power.
2. Disconnect the power cord from MB.
3. Take out the battery gently and put it aside for about 1 minute (Or you can use a metal object to connect the positive and negative pins in the battery holder to makethem short for 5 seconds).
4. Re-insert the battery to the battery holder.
5. Connect power cord to MB again and turn on power.
6. Press Del to enter BIOS and load Fail-Safe Defaults(or load Optimized Defaults).
7. Save changes and reboot the system.

Question 4: Why do I still get a weak sound after turning up the speaker to the maximum volume?

Answer: Please make sure the speaker you are using is equipped with an internal amplifier. If not, please change another speaker with power/amplifier and try again later.

Question 5: Sometimes I hear different continuous beeps from computer after system boots up. What do these beeps usually stand for?

Answer: The beep codes below may help you identify the possible computer problems. However, they are only for reference purposes. The situations might differ from case to case.

→ AWARD BIOS Beep Codes

- 1 short: System boots successfully
- 2 short: CMOS setting error
- 1 long 1 short: DRAM or M/B error
- 1 long 2 short: Monitor or display card error
- 1 long 3 short: Keyboard error
- 1 long 9 short: BIOS ROM error
- Continuous long beeps: DRAM error
- Continuous short beeps: Power error



---

---

---

---

---

---

---

---

---

---

---

---

---

---

---

---

---

---

---

---

---

---

---

---

---

---



Lined writing area consisting of 26 horizontal lines.



## Contact Us

---

- **Taiwan (Headquarters)**

GIGA-BYTE TECHNOLOGY CO., LTD.

Address: No.6, Bau Chiang Road, Hsin-Tien,

Taipei 231, Taiwan

TEL: +886-2-8912-4888

FAX: +886-2-8912-4003

Tech. and Non-Tech. Support (Sales/Marketing) :

<http://ggts.gigabyte.com.tw>

WEB address (English): <http://www.gigabyte.com.tw>

WEB address (Chinese): <http://www.gigabyte.tw>

---

- **U.S.A.**

G.B.T. INC.

TEL: +1-626-854-9338

FAX: +1-626-854-9339

Tech. Support:

<http://rma.gigabyte-usa.com>

Web address: <http://www.gigabyte.us>

---

- **Mexico**

G.B.T Inc (USA)

Tel: +1-626-854-9338 x 215 (Soporte de habla hispano)

FAX: +1-626-854-9339

Correo: [soporte@gigabyte-usa.com](mailto:soporte@gigabyte-usa.com)

Tech. Support:

<http://rma.gigabyte-usa.com>

Web address: <http://www.gigabyte-latam.com>

---

- **Japan**

NIPPON GIGA-BYTE CORPORATION

WEB address : <http://www.gigabyte.co.jp>

---

- **Singapore**

GIGA-BYTE SINGAPORE PTE. LTD.

WEB address : <http://www.gigabyte.com.sg>

---



---

- **China**

NINGBO G.B.T. TECH. TRADING CO., LTD.

WEB address : <http://www.gigabyte.cn>

- **Shanghai**

TEL: +86-21-63410999

FAX: +86-21-63410100

- **Beijing**

TEL: +86-10-62102838

FAX: +86-10-62102848

- **Wuhan**

TEL: +86-27-87851061

FAX: +86-27-87851330

- **GuangZhou**

TEL: +86-20-87540700

FAX: +86-20-87544306 ext. 333

- **Chengdu**

TEL: +86-28-85236930

FAX: +86-28-85256822 ext. 814

- **Xian**

TEL: +86-29-85531943

FAX: +86-29-85539821

- **Shenyang**

TEL: +86-24-83992901

FAX: +86-24-83992909

---

- **India**

GIGABYTE TECHNOLOGY (INDIA) LIMITED

WEB address : <http://www.gigabyte.in>

---

- **Australia**

GIGABYTE TECHNOLOGY PTY. LTD.

WEB address : <http://www.gigabyte.com.au>

---

---

- **Germany**

G.B.T. TECHNOLOGY TRADING GMBH

WEB address : <http://www.gigabyte.de>

---

- **U.K.**

G.B.T. TECH. CO., LTD.

WEB address : <http://www.giga-byte.co.uk>

---

- **The Netherlands**

GIGA-BYTE TECHNOLOGY B.V.

WEB address : <http://www.giga-byte.nl>

---

- **France**

GIGABYTE TECHNOLOGY FRANCE

WEB address : <http://www.gigabyte.fr>

---

- **Italy**

WEB address : <http://www.giga-byte.it>

---

- **Spain**

GIGA-BYTE SPAIN

WEB address : <http://www.giga-byte.es>

---

- **Czech Republic**

Representative Office Of GIGA-BYTE Technology Co., Ltd.  
in CZECH REPUBLIC

WEB address : <http://www.gigabyte.cz>

---

- **Turkey**

Representative Office Of GIGA-BYTE Technology Co., Ltd.  
in TURKEY

WEB address : <http://www.gigabyte.com.tr>

---



---

- **Russia**

Moscow Representative Office Of GIGA-BYTE Technology Co., Ltd.

WEB address : <http://www.gigabyte.ru>

---

- **Latvia**

GIGA-BYTE Latvia

WEB address : <http://www.gigabyte.com.lv>

---

- **Poland**

Office of GIGA-BYTE TECHNOLOGY Co., Ltd. in POLAND

WEB address : <http://www.gigabyte.pl>

---

- **Ukraine**

WEB address : <http://www.gigabyte.kiev.ua>

---

- **Romania**

Representative Office Of GIGA-BYTE Technology Co., Ltd.  
in Romania

WEB address : <http://www.gigabyte.com.ro>

---

- **Serbia & Montenegro**

Representative Office Of GIGA-BYTE Technology Co., Ltd.  
in SERBIA & MONTENEGRO

WEB address : <http://www.gigabyte.co.yu>

---

- **GIGABYTE Global Service System**



To submit a technical or non-technical (Sales/ Marketing) question, please link to :

<http://ggts.gigabyte.com.tw>

Then select your language to enter the system.



关于符合中国《电子信息产品污染控制管理办法》的声明  
 Management Methods on Control of Pollution from Electronic Information Products  
 (China RoHS Declaration)

产品中有毒有害物质或元素的名称及含量  
 Hazardous Substances Table

部件名称 (Parts)	有毒有害物质或元素 (Hazardous Substances)					
	铅 (Pb)	汞 (Hg)	镉 (Cd)	六价铬 (Cr (VI))	多溴联苯 (PBB)	多溴二苯醚 (PBDE)
PCB板 PCB	○	○	○	○	○	○
结构件及风扇 Mechanical parts and Fan	×	○	○	○	○	○
芯片及其他主动零件 Chip and other Active components	×	○	○	○	○	○
连接器 Connectors	×	○	○	○	○	○
被动电子元件 Passive Components	×	○	○	○	○	○
线材 Cables	○	○	○	○	○	○
焊接金属 Soldering metal	○	○	○	○	○	○
助焊剂, 散热膏, 标签及其他耗材 Flux, Solder Paste, Label and other Consumable Materials	○	○	○	○	○	○
○: 表示该有毒有害物质在该部件所有均质材料中的含量均在SJ/T11363-2006标准规定的限量要求以下。 Indicates that this hazardous substance contained in all homogenous materials of this part is below the limit requirement SJ/T 11363-2006						
×: 表示该有毒有害物质至少在该部件的某一均质材料中的含量超出SJ/T11363-2006标准规定的限量要求。 Indicates that this hazardous substance contained in at least one of the homogenous materials of this part is above the limit requirement in SJ/T 11363-2006						
对销售之日的所发售产品, 本表显示我公司供应链的电子信息产品可能包含这些物质。注意: 在所售产品中可能会也可能不会含有所有列出的部件。 This table shows where these substances may be found in the supply chain of our electronic information products, as of the date of the sale of the enclosed products. Note that some of the component types listed above may or may not be a part of the enclosed product.						